EMC Test Report

Report No.: AGC05443251125EE01

PRODUCT DESIGNATION : Handwarmer power bank
BRAND NAME : N/A
MODEL NAME : M02777
APPLICANT : MID OCEAN BRANDS B.V.
DATE OF ISSUE : Nov. 21, 2025
STANDARD(S) : EN IEC 55014-1:2021
EN IEC 55014-2:2021
EN IEC 61000-3-2:2019+A1:2021+A2:2024
EN 61000-3-3:2013+A1:2019+A2:2021
REPORT VERSION : V1.0



Attestation of Global Compliance (Shenzhen) Co., Ltd

Any report having not been signed by authorized approver, or having been altered without authorization, or having not been stamped by the "Dedicated Testing/Inspection Stamp" is deemed to be invalid. Copying or excerpting portion of, or altering the content of the report is not permitted without the written authorization of AGC. The test results presented in the report apply only to the tested sample. Any objections to report issued by AGC should be submitted to AGC within 15days after the issuance of the test report. Further enquiry of validity or verification of the test report should be addressed to AGC by agc01@agccert.com.

Attestation of Global Compliance(Shenzhen)Co., Ltd
Attestation of Global Compliance(Shenzhen)Std & Tech Co., Ltd
Tel: +86-755 2523 4088 E-mail: agc@agccert.com Web: <http://www.agccert.com/>



REPORT REVISE RECORD

Report Version	Revise Time	Issued Date	Valid Version	Notes
V1.0	/	Nov. 21, 2025	Valid	Initial release

Any report having not been signed by authorized approver, or having been altered without authorization, or having not been stamped by the "Dedicated Testing/Inspection Stamp" is deemed to be invalid. Copying or excerpting portion of, or altering the content of the report is not permitted without the written authorization of AGC. The test results presented in the report apply only to the tested sample. Any objections to report issued by AGC should be submitted to AGC within 15days after the issuance of the test report. Further enquiry of validity or verification of the test report should be addressed to AGC by agc01@agccert.com.

Attestation of Global Compliance(Shenzhen)Co., Ltd
Attestation of Global Compliance(Shenzhen)Std & Tech Co., Ltd
Tel: +86-755 2523 4088 E-mail: agc@agccert.com Web: <http://www.agccert.com/>

Table of contents

1. General information 5

2. Description of Test Configuration 6

 2.1. Technical Description of Product 6

 2.2. Description of Support Equipment 6

 2.3. Description of Test Modes..... 6

3. Summary of Measurement Results and Uncertainty 7

 3.1. Test Specifications 7

 3.2. Description of Measurement Results..... 7

 3.3. Description of Measurement Uncertainty 9

4. Test Facility 10

5. Measurement of Conducted Emissions from the AC Mains Power Ports 11

 5.1. Requirements..... 11

 5.2. Block Diagram of Test Setup..... 12

 5.3. Equipment Details 13

 5.4. Configuration of the EUT and method of measurement..... 13

 5.5. Test Summary 14

6. Measurement of Radiated Emissions at Frequencies up to 1 GHz 16

 6.1. Requirements..... 16

 6.2. Block Diagram of Test Setup..... 16

 6.3. Equipment Details 17

 6.4. Configuration of the EUT and method of measurement..... 17

 6.5. Test Summary 18

7. Measurement of Harmonic Current Emissions..... 20

 7.1. Requirements..... 20

 7.2. Block Diagram of Test Setup..... 21

 7.3. Equipment Details 21

 7.4. Configuration of the EUT and method of measurement..... 21

 7.5. Test Summary 22

8. Measurement of Voltage Fluctuations and Flicker 23

 8.1. Requirements..... 23

 8.2. Block Diagram of Test Setup..... 23

 8.3. Equipment Details 23

 8.4. Configuration of the EUT and method of measurement..... 24

Any report having not been signed by authorized approver, or having been altered without authorization, or having not been stamped by the “Dedicated Testing/Inspection Stamp” is deemed to be invalid. Copying or excerpting portion of, or altering the content of the report is not permitted without the written authorization of AGC. The test results presented in the report apply only to the tested sample. Any objections to report issued by AGC should be submitted to AGC within 15days after the issuance of the test report. Further enquiry of validity or verification of the test report should be addressed to AGC by agc01@agccert.com.

8.5. Test Summary	24
9. Measurement of Electrostatic discharge.....	25
9.1. Requirements.....	25
9.2. Block Diagram of Test Setup.....	25
9.3. Equipment Details	26
9.4. Configuration of the EUT and method of measurement.....	26
9.5. Test Summary	27
10. Measurement of Radio-Frequency Electromagnetic Field	28
10.1. Requirements	28
10.2. Block Diagram of Test Setup	29
10.3. Equipment Details	30
10.4. Configuration of the EUT and method of measurement	30
10.5. Test Summary.....	31
11. Measurement of Radio-frequency common mode	32
11.1. Requirements	32
11.2. Block Diagram of Test Setup.....	32
11.3. Equipment Details	33
11.4. Configuration of the EUT and method of measurement	33
11.5. Test Summary.....	34
12. Measurement of Fast Transients	35
12.1. Requirements	35
12.2. Block Diagram of Test Setup.....	35
12.3. Equipment Details	36
12.4. Configuration of the EUT and method of measurement	36
12.5. Test Summary.....	37
13. Measurement of Surges	38
13.1. Requirements	38
13.2. Block Diagram of Test Setup.....	38
13.3. Equipment Details	39
13.4. Configuration of the EUT and method of measurement	39
13.5. Test Summary.....	39
14. Photographs of Test Setup	40
15. Photographs of EUT	44

Any report having not been signed by authorized approver, or having been altered without authorization, or having not been stamped by the “Dedicated Testing/Inspection Stamp” is deemed to be invalid. Copying or excerpting portion of, or altering the content of the report is not permitted without the written authorization of AGC. The test results presented in the report apply only to the tested sample. Any objections to report issued by AGC should be submitted to AGC within 15days after the issuance of the test report. Further enquiry of validity or verification of the test report should be addressed to AGC by agc01@agccert.com.

1. General information

Applicant	MID OCEAN BRANDS B.V.
Address	Unit 711-716, 7/F., Tower A, 83 King Lam Street, Cheung Sha Wan, Kowloon, Hong Kong.
Manufacturer	MID OCEAN BRANDS B.V.
Address	Unit 711-716, 7/F., Tower A, 83 King Lam Street, Cheung Sha Wan, Kowloon, Hong Kong.
Factory	MID OCEAN BRANDS B.V.
Address	Unit 711-716, 7/F., Tower A, 83 King Lam Street, Cheung Sha Wan, Kowloon, Hong Kong.
Product Designation	Handwarmer power bank
Brand Name	N/A
Test Model	MO2777
Series Model(s)	N/A
Difference Description	N/A
Deviation from Standard	No any deviation from the test method
Date of receipt of test item	Nov. 13, 2025
Date of Test	Nov. 13, 2025 to Nov. 21, 2025
Test Result	Pass
Test Report Form No	AGCER-EMC-GEN-V1
Note: The test results of this report relate only to the tested sample identified in this report.	

Prepared By



Cici Li
(Project Engineer)

Nov. 21, 2025

Reviewed By



Jack Gui
(Reviewer)

Nov. 21, 2025

Approved By



Angela Li
(Authorized Officer)

Nov. 21, 2025

Any report having not been signed by authorized approver, or having been altered without authorization, or having not been stamped by the "Dedicated Testing/Inspection Stamp" is deemed to be invalid. Copying or excerpting portion of, or altering the content of the report is not permitted without the written authorization of AGC. The test results presented in the report apply only to the tested sample. Any objections to report issued by AGC should be submitted to AGC within 15days after the issuance of the test report. Further enquiry of validity or verification of the test report should be addressed to AGC by agc01@agccert.com.

2. Description of Test Configuration

2.1. Technical Description of Product

Categorization of Equipment	Category III equipment
Test arrangements of EUT	Table-top
Hardware Version	N/A
Software Version	N/A
Highest Internal Frequency	Less than 108MHz
EUT Input Rating	Type-C: DC 5V 1.5A
EUT Output Rating	USB-A: DC 5V 1A
Battery Information	DC 3.7V 5000mAh

Connection Diagram of Host System

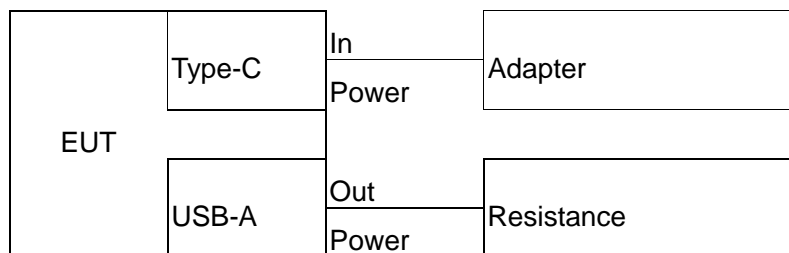

I/O Port Information (Applicable Not Applicable)

Port Type	Input/Output	Number	Cable Description
Type-C	In	1	0.5m unshielded
USB-A	Out	1	--

2.2. Description of Support Equipment

Device Type	Manufacturer	Model Name	Serial No.	Data Cable	Power Cable
Adapter	Apple	A2452	--	--	1.0m unshielded

2.3. Description of Test Modes

No.	Test Mode Description
1	Charging mode
2	Heating mode

Note: All modes have been tested for EMI and the worst mode is finally reflected.

Any report having not been signed by authorized approver, or having been altered without authorization, or having not been stamped by the "Dedicated Testing/Inspection Stamp" is deemed to be invalid. Copying or excerpting portion of, or altering the content of the report is not permitted without the written authorization of AGC. The test results presented in the report apply only to the tested sample. Any objections to report issued by AGC should be submitted to AGC within 15days after the issuance of the test report. Further enquiry of validity or verification of the test report should be addressed to AGC by agc01@agccert.com.

3. Summary of Measurement Results and Uncertainty

3.1. Test Specifications

EN IEC 55014-1:2021	Electromagnetic compatibility - Requirements for household appliances, electric tools and similar apparatus - Part 1: Emission
EN IEC 55014-2:2021	Electromagnetic compatibility - Requirements for household appliances, electric tools and similar apparatus - Part 2: Immunity - Product family standard
EN IEC 61000-3-2:2019+A1:2021+A2:2024	Electromagnetic compatibility (EMC) - Part 3-2: Limits - Limits for harmonic current emissions (equipment input current 16 A per phase)
EN 61000-3-3:2013+A1:2019+A2:2021	Electromagnetic compatibility (EMC) Part 3-3: Limits - Limitation of voltage changes, voltage fluctuations and flicker in public low-voltage supply systems, for equipment with rated current ≤ 16 A per phase and not subject to conditional connection

3.2. Description of Measurement Results

Test items	Test Standard(s)	Verdict
Conducted emissions from the AC mains power ports	EN IEC 55014-1	Pass
Radiated emissions at frequencies up to 1 GHz	EN IEC 55014-1	Pass
Harmonic current emissions	EN IEC 61000-3-2	Pass
Voltage fluctuations and flicker	EN 61000-3-3	Pass
Electrostatic discharge	IEC 61000-4-2 ^a	Pass
Radio-frequency electromagnetic field	IEC 61000-4-3 ^a	Pass
Fast transients	IEC 61000-4-4 ^a	Pass
Surges	IEC 61000-4-5 ^a	Pass
Radio-frequency common mode (Injected currents)	IEC 61000-4-6 ^a	Pass
Note: a. The applicable versions of the basic standards are defined in the standard which listed in the test specification.		

Any report having not been signed by authorized approver, or having been altered without authorization, or having not been stamped by the "Dedicated Testing/Inspection Stamp" is deemed to be invalid. Copying or excerpting portion of, or altering the content of the report is not permitted without the written authorization of AGC. The test results presented in the report apply only to the tested sample. Any objections to report issued by AGC should be submitted to AGC within 15days after the issuance of the test report. Further enquiry of validity or verification of the test report should be addressed to AGC by agc01@agccert.com.

Performance table

Performance Criteria for Immunity	
Performance criterion A	The apparatus shall continue to operate as intended during the test. No degradation of performance or loss of function is allowed below a performance level (or permissible loss of performance) specified by the manufacturer, when the apparatus is used as intended. If the minimum performance level or the permissible performance loss is not specified by the manufacturer, then either of these may be derived from the product description and documentation, and from what the user may reasonably expect from the apparatus if used as intended.
Performance criterion B	The apparatus shall continue to operate as intended after the test. No degradation of performance or loss of function is allowed below a performance level (or permissible loss of performance) specified by the manufacturer, when the apparatus is used as intended. During the test, degradation of performance is allowed, however no change of actual operating state or stored data is allowed to persist after the test. If the minimum performance level or the permissible performance loss is not specified by the manufacturer, then either of these may be derived from the product description and documentation, and from what the user may reasonably expect from the apparatus if used as intended.
Performance criterion C	Temporary loss of function is allowed, provided the function is self-recoverable or can be restored by the operation of the controls, or by any operation specified in the instructions for use.

Any report having not been signed by authorized approver, or having been altered without authorization, or having not been stamped by the "Dedicated Testing/Inspection Stamp" is deemed to be invalid. Copying or excerpting portion of, or altering the content of the report is not permitted without the written authorization of AGC. The test results presented in the report apply only to the tested sample. Any objections to report issued by AGC should be submitted to AGC within 15days after the issuance of the test report. Further enquiry of validity or verification of the test report should be addressed to AGC by agc01@agccert.com.

3.3. Description of Measurement Uncertainty

The reported uncertainty of measurement $y \pm U$, where expanded uncertainty U is based on a standard uncertainty multiplied by a coverage factor of $k=2$, providing a level of confidence of approximately 95%.

Item	Measurement Uncertainty
Conducted emissions from the AC mains power ports	$U_c = \pm 2.9$ dB
Radiated emissions at frequencies up to 1 GHz	$U_c = \pm 3.9$ dB

Any report having not been signed by authorized approver, or having been altered without authorization, or having not been stamped by the "Dedicated Testing/Inspection Stamp" is deemed to be invalid. Copying or excerpting portion of, or altering the content of the report is not permitted without the written authorization of AGC. The test results presented in the report apply only to the tested sample. Any objections to report issued by AGC should be submitted to AGC within 15 days after the issuance of the test report. Further enquiry of validity or verification of the test report should be addressed to AGC by agc01@agccert.com.

4. Test Facility

Laboratory name: Attestation of Global Compliance (Shenzhen) Co., Ltd.

Laboratory Address: 1-2/F, Building 19, Junfeng Industrial Park, Chongqing Road, Heping Community, Fuhai Street, Bao'an District, Shenzhen, Guangdong, China

The test facility is recognized, certified, or accredited by the following organizations:

CNAS-Lab Code: L5488

Attestation of Global Compliance (Shenzhen) Co., Ltd. is accredited in accordance with the recognized International Standard ISO/IEC 17025 General Requirements for the Competence of Testing and Calibration Laboratories (CNAS-CL01 Accreditation Criteria for Testing and Calibration Laboratories).

A2LA-Lab Cert. No.: 5054.02

Attestation of Global Compliance (Shenzhen) Co., Ltd. is accredited in accordance with the recognized International Standard ISO/IEC 17025:2017 General requirements for the competence of testing and calibration laboratories. This laboratory also meets the requirements of any additional program requirements in the Electrical field.

FCC-Registration No.: 975832

Attestation of Global Compliance (Shenzhen) Co., Ltd. EMC Laboratory has been registered and fully described in a report filed with the FCC (Federal Communications Commission). The acceptance letter from the FCC is maintained in our files with Registration 975832.

IC-Registration No.: 24842

CAB identifier: CN0063

Attestation of Global Compliance (Shenzhen) Co., Ltd. EMC Laboratory has been registered and fully described in a report filed with the Certification and Engineering Bureau of Industry Canada. The acceptance letter from the IC is maintained in our files with Registration 24842.

VCCI Membership No.: 4112

Attestation of Global Compliance (Shenzhen) Co., Ltd. EMC Laboratory has been registered in accordance with VCCI Council Rules.

VCCI Registration No. C-20098 for conducted emissions at AC main power ports

VCCI Registration No. T-20102 for conducted emissions at telecommunication ports

VCCI Registration No. R-20136 for radiated emissions below 1GHz

VCCI Registration No. G-20132 for radiated emissions above 1GHz

Any report having not been signed by authorized approver, or having been altered without authorization, or having not been stamped by the "Dedicated Testing/Inspection Stamp" is deemed to be invalid. Copying or excerpting portion of, or altering the content of the report is not permitted without the written authorization of AGC. The test results presented in the report apply only to the tested sample. Any objections to report issued by AGC should be submitted to AGC within 15days after the issuance of the test report. Further enquiry of validity or verification of the test report should be addressed to AGC by agc01@agccert.com.

5. Measurement of Conducted Emissions from the AC Mains Power Ports

5.1. Requirements

General limits for conducted emissions, low voltage AC mains port

Network device	Detector type/ bandwidth	Frequency Range (MHz)	Limits dB(μV)	Measurement specifications
AMN	Quasi-peak/ 9kHz	0.15 to 0.5	66 to 56	Instrumentation: CISPR 16-1-1, Clauses 4, 5 and 7 Networks: CISPR 16-1-2, Clause 4 Method: CISPR 16-2-1, Clause 7 Set-up: CISPR 16-2-1, Clause 7
		0.5 to 5	56	
		5 to 30	60	
	Average/ 9kHz	0.15 to 0.5	59 to 46	
		0.5 to 5	46	
		5 to 30	50	

Note:

1. The lower limit shall apply at the transition frequency.
2. The limit decreases linearly with the logarithm of the frequency in the range 0.15 to 0.5MHz.

Limits for the mains port of motor operated tools

Frequency range	Tools (P = rated power of the motor only.)					
	P ≤ 700 W		700 W < P ≤ 1 000 W		P > 1 000 W	
1	2	3	4	5	6	7
MHz	Quasi-peak dB(μV)	Average dB(μV)	Quasi-peak dB(μV)	Average dB(μV)	Quasi-peak dB(μV)	Average dB(μV)
0.15 to 0.35	66 to 59	59 to 49	70 to 63	63 to 53	76 to 69	69 to 59
0.35 to 5	59	49	63	53	69	59
5 to 30	64	54	68	58	74	64

Note:

1. The lower limit shall apply at the transition frequency.
2. The limit decreases linearly with the logarithm of the frequency in the range 0.15 to 0.35MHz.

Any report having not been signed by authorized approver, or having been altered without authorization, or having not been stamped by the "Dedicated Testing/Inspection Stamp" is deemed to be invalid. Copying or excerpting portion of, or altering the content of the report is not permitted without the written authorization of AGC. The test results presented in the report apply only to the tested sample. Any objections to report issued by AGC should be submitted to AGC within 15days after the issuance of the test report. Further enquiry of validity or verification of the test report should be addressed to AGC by agc01@agccert.com.

5.2. Block Diagram of Test Setup

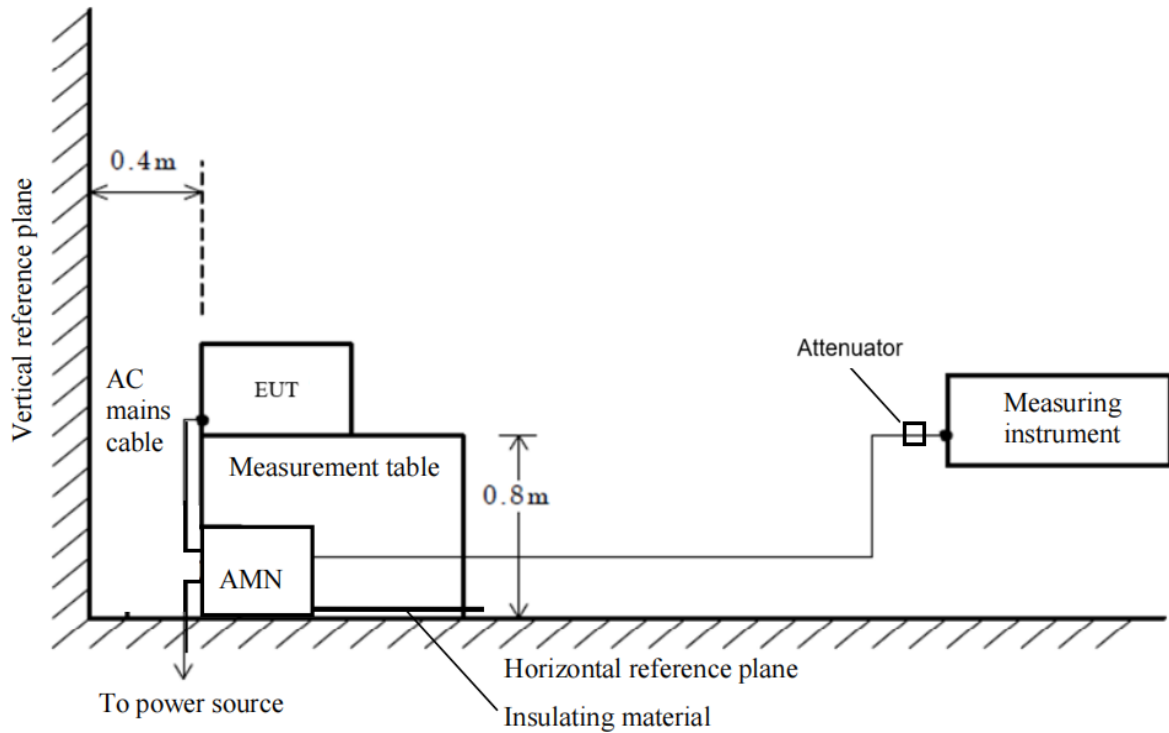

Any report having not been signed by authorized approver, or having been altered without authorization, or having not been stamped by the “Dedicated Testing/Inspection Stamp” is deemed to be invalid. Copying or excerpting portion of, or altering the content of the report is not permitted without the written authorization of AGC. The test results presented in the report apply only to the tested sample. Any objections to report issued by AGC should be submitted to AGC within 15 days after the issuance of the test report. Further enquiry of validity or verification of the test report should be addressed to AGC by agc01@agccert.com.

5.3. Equipment Details

Measuring Instruments

Instruments No.	Instruments	Manufacturer	Model	S/N	Cal. Date	Cal. Due
AGC-EM-E116	Test Receiver	R&S	ESCI	100034	2025-05-08	2026-05-07
AGC-EM-E023	Artificial Mains Network	R&S	ESH2-Z5	100086	2025-05-08	2026-05-07
AGC-EM-A171	Attenuator	Mini-Circuits	UNAT-10A+	N/A	2024-02-01	2026-01-31

Measuring Software

Software No.	Software Name	Manufacturer	Details
AGC-EM-S001	ES-K1	R&S	For EMC Measurement, Version 1.71

5.4. Configuration of the EUT and method of measurement

- a. The EUT was set up as per the test configuration to simulate typical actual usage per the user's manual. When the EUT is a tabletop system, the EUT was placed on the top surface of a measurement table, 0.8 m high from the horizontal reference plane, and was positioned at a distance of 0.4 m away from the vertical reference plane. When the EUT is a floor-standing equipment, it is placed on the ground plane which has a 10 cm non-conductive covering to insulate the EUT from the ground plane.
- b. Support equipment, if needed, was placed as per CISPR 16-2-1.
- c. All I/O cables were positioned to simulate typical actual usage as per CISPR 16-2-1.
- d. The EMI receiver measured the emission levels emanating from the EUT into the AC Mains through an Artificial Mains Network (AMN) and an attenuator used on the front end of the EMI receiver. Testing included measurements on all live and neutral lines.
- e. The more description of the tests, the test methods, and the test set-ups are given in the applicable test standard.
- f. Record at least six highest emissions relative to the limits at each frequency of interest unless the emission is 10 dB or greater below the limit.
- g. A conducted emission is calculated by the following equation:
 - Measurement Level (dB μ V) = Receiver reading (dB μ V) + Tansd (dB)
 - Transd(dB)= AMN Factor(dB)+Cable Loss(dB)+Attenuation(dB)
 - Margin= Limit-Level

Any report having not been signed by authorized approver, or having been altered without authorization, or having not been stamped by the "Dedicated Testing/Inspection Stamp" is deemed to be invalid. Copying or excerpting portion of, or altering the content of the report is not permitted without the written authorization of AGC. The test results presented in the report apply only to the tested sample. Any objections to report issued by AGC should be submitted to AGC within 15days after the issuance of the test report. Further enquiry of validity or verification of the test report should be addressed to AGC by agc01@agccert.com.

5.5. Test Summary

Test Engineer	Kobe Chen	Temperature	21.5°C
Test Date	2025-11-18	Air Pressure	985 Mbar
Test Mode	Mode 1	Relative Humidity	52.2%
Verdict	Pass		

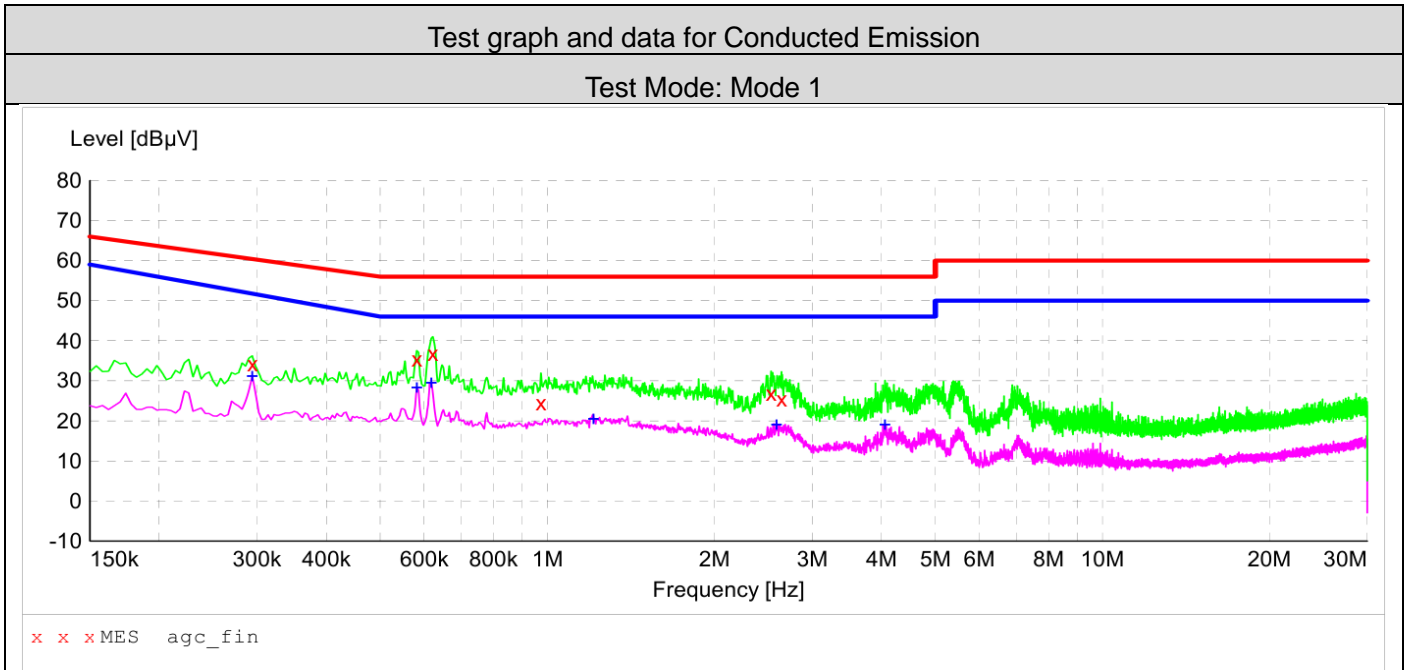

Frequency [MHz]	Level [dBµV]	Factor [dB]	Limit [dBµV]	Margin [dB]	Detector	Line
0.294000	34.1	10.3	60.4	26.3	QP	L1
0.582000	35.4	10.3	56.0	20.6	QP	L1
0.622000	36.8	10.3	56.0	19.2	QP	L1
0.974000	24.4	10.4	56.0	31.6	QP	L1
2.530000	26.8	10.5	56.0	29.2	QP	L1
2.642000	25.4	10.5	56.0	30.6	QP	L1
0.294000	31.1	10.3	51.7	20.6	AV	L1
0.582000	28.3	10.3	46.0	17.7	AV	L1
0.618000	29.4	10.3	46.0	16.6	AV	L1
1.210000	20.3	10.4	46.0	25.7	AV	L1
2.586000	19.1	10.5	46.0	26.9	AV	L1
4.058000	19.0	10.7	46.0	27.0	AV	L1

Any report having not been signed by authorized approver, or having been altered without authorization, or having not been stamped by the "Dedicated Testing/Inspection Stamp" is deemed to be invalid. Copying or excerpting portion of, or altering the content of the report is not permitted without the written authorization of AGC. The test results presented in the report apply only to the tested sample. Any objections to report issued by AGC should be submitted to AGC within 15days after the issuance of the test report. Further enquiry of validity or verification of the test report should be addressed to AGC by agc01@agccert.com.

Test graph and data for Conducted Emission

Test Mode: Mode 1

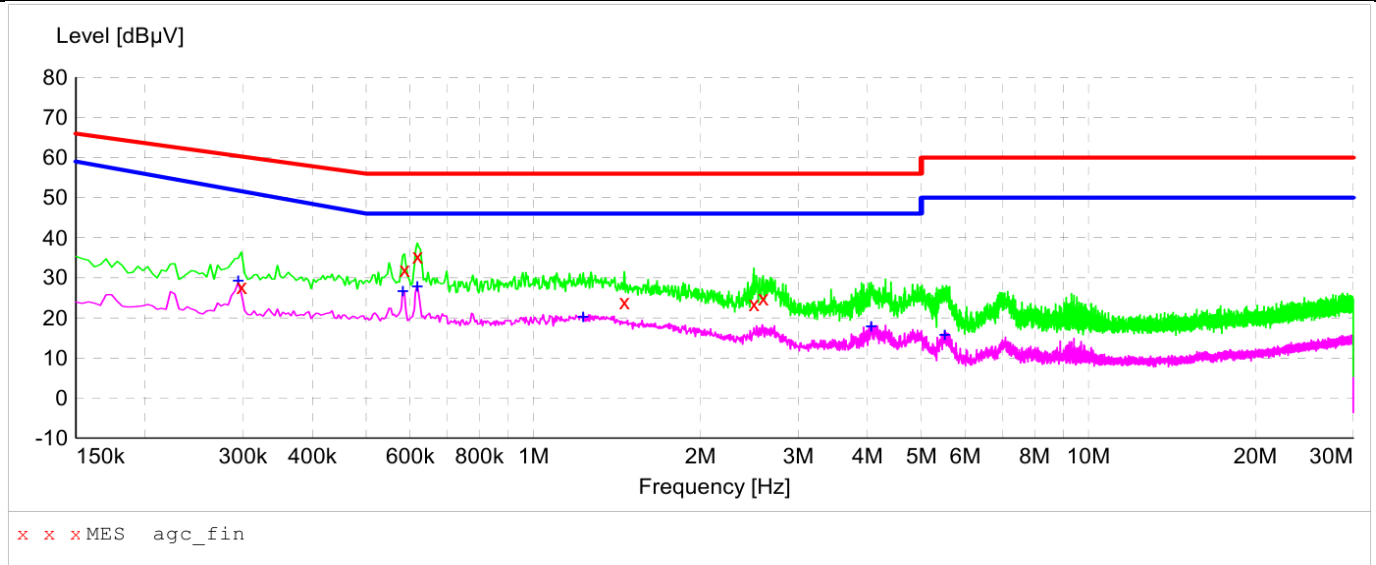

Frequency [MHz]	Level [dBµV]	Factor [dB]	Limit [dBµV]	Margin [dB]	Detector	Line
0.298000	27.8	10.3	60.3	32.5	QP	N
0.586000	32.1	10.3	56.0	23.9	QP	N
0.618000	35.4	10.3	56.0	20.6	QP	N
1.458000	23.9	10.4	56.0	32.1	QP	N
2.498000	23.6	10.5	56.0	32.4	QP	N
2.594000	25.0	10.5	56.0	31.0	QP	N
0.294000	29.2	10.3	51.7	22.5	AV	N
0.582000	26.6	10.3	46.0	19.4	AV	N
0.618000	27.7	10.3	46.0	18.3	AV	N
1.230000	20.1	10.4	46.0	25.9	AV	N
4.062000	17.9	10.7	46.0	28.1	AV	N
5.510000	15.7	11.0	50.0	34.3	AV	N

Any report having not been signed by authorized approver, or having been altered without authorization, or having not been stamped by the "Dedicated Testing/Inspection Stamp" is deemed to be invalid. Copying or excerpting portion of, or altering the content of the report is not permitted without the written authorization of AGC. The test results presented in the report apply only to the tested sample. Any objections to report issued by AGC should be submitted to AGC within 15days after the issuance of the test report. Further enquiry of validity or verification of the test report should be addressed to AGC by agc01@agccert.com.

6. Measurement of Radiated Emissions at Frequencies up to 1 GHz

6.1. Requirements

Requirements for radiated emissions at frequencies up to 1 GHz at 3m distance

Test facility	Detector type/ bandwidth	Frequency Range (MHz)	Limits dB(μ V/m)	Measurement specifications
SAC	Quasi-peak/ 120kHz	30 to 230	40	Instrumentation: CISPR 16-1-1, Clauses 4, 5 Antennas: CISPR 16-1-4, Clause 4.5 Test Site: CISPR 16-1-4, Clause 6 Method: CISPR 16-2-3, Clause 7.6
		230 to 1000	47	

Note:

- The lower limit shall apply at the transition frequency.

6.2. Block Diagram of Test Setup

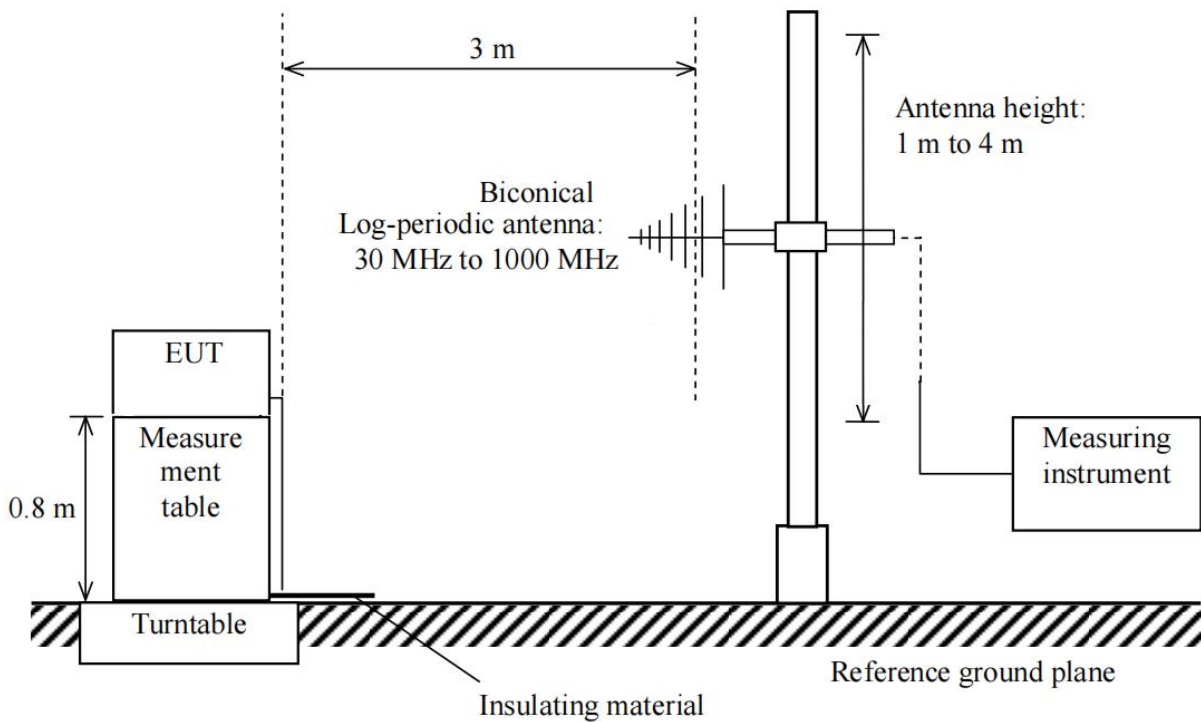

Any report having not been signed by authorized approver, or having been altered without authorization, or having not been stamped by the "Dedicated Testing/Inspection Stamp" is deemed to be invalid. Copying or excerpting portion of, or altering the content of the report is not permitted without the written authorization of AGC. The test results presented in the report apply only to the tested sample. Any objections to report issued by AGC should be submitted to AGC within 15 days after the issuance of the test report. Further enquiry of validity or verification of the test report should be addressed to AGC by agc01@agccert.com.

6.3. Equipment Details

Measuring Instruments

Instruments No.	Instruments	Manufacturer	Model	S/N	Cal. Date	Cal. Due
AGC-EM-E046	Test Receiver	R&S	ESCI	100096	2025-01-14	2026-01-13
AGC-EM-E001	Antenna	SCHWARZBECK	VULB9168	D69250	2025-03-14	2027-03-13
AGC-EM-A138	Attenuator	East sheep	LM-XX-6-5W	N/A	2025-05-16	2027-05-15

Measuring Software

Software No.	Software Name	Manufacturer	Details
AGC-EM-S004	TS+[JS32-RE]	Tonscend	For EMC Measurement, Version 4.0.0.0

6.4. Configuration of the EUT and method of measurement

- a. The EUT was set up as per the test configuration to simulate typical actual usage per the user's manual. When the EUT is a tabletop system, the EUT was placed on the top surface of a measurement table, 0.8 m high from the horizontal reference plane. When the EUT is a floor-standing equipment, it is placed on the ground plane which has a 10 cm non-conductive covering to insulate the EUT from the ground plane.
- b. Support equipment, if needed, was placed as per CISPR 16-2-3.
- c. All I/O cables were positioned to simulate typical actual usage as per CISPR 16-2-3.
- d. The maximum receiving level of radiated emissions from the EUT was measured while the turntable was rotated from 0° to 360° and the antenna height was scanned between 1 m and 4 m. The cables were laid out to attain the maximum level of radiated emissions.
- e. The more description of the tests, the test methods, and the test set-ups are given in the applicable test standard.
- f. Record at least six highest emissions relative to the limits at each frequency of interest unless the emission is 10 dB or greater below the limit.
- g. A radiated emission is calculated by the following equation:
 - Measurement Level dB(μV/m) = Receiver reading dB(μV) + Factor(dB/m)
 - Factor(dB/m) = Antenna Factor(dB/m) + Cable Loss(dB)
 - Margin= Limit-Level

Any report having not been signed by authorized approver, or having been altered without authorization, or having not been stamped by the "Dedicated Testing/Inspection Stamp" is deemed to be invalid. Copying or excerpting portion of, or altering the content of the report is not permitted without the written authorization of AGC. The test results presented in the report apply only to the tested sample. Any objections to report issued by AGC should be submitted to AGC within 15days after the issuance of the test report. Further enquiry of validity or verification of the test report should be addressed to AGC by agc01@agccert.com.

6.5. Test Summary

Test Engineer	Tom Chen	Temperature	22.4°C
Test Date	2025-11-17	Air Pressure	985 Mbar
Test Mode	Mode 1	Relative Humidity	54.8 %
Verdict	Pass		

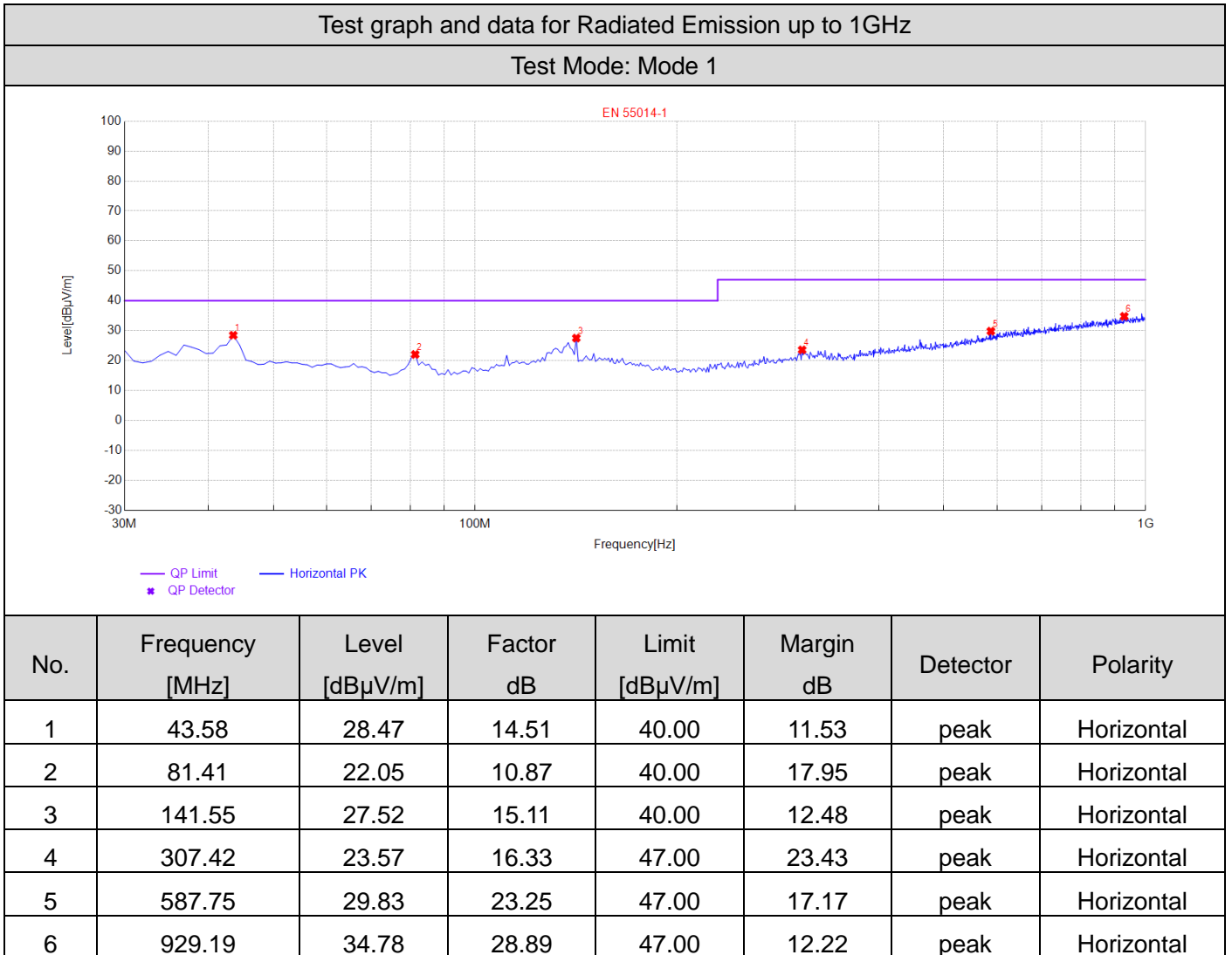

Any report having not been signed by authorized approver, or having been altered without authorization, or having not been stamped by the “Dedicated Testing/Inspection Stamp” is deemed to be invalid. Copying or excerpting portion of, or altering the content of the report is not permitted without the written authorization of AGC. The test results presented in the report apply only to the tested sample. Any objections to report issued by AGC should be submitted to AGC within 15days after the issuance of the test report. Further enquiry of validity or verification of the test report should be addressed to AGC by agc01@agccert.com.

Test graph and data for Radiated Emission up to 1GHz

Test Mode: Mode 1

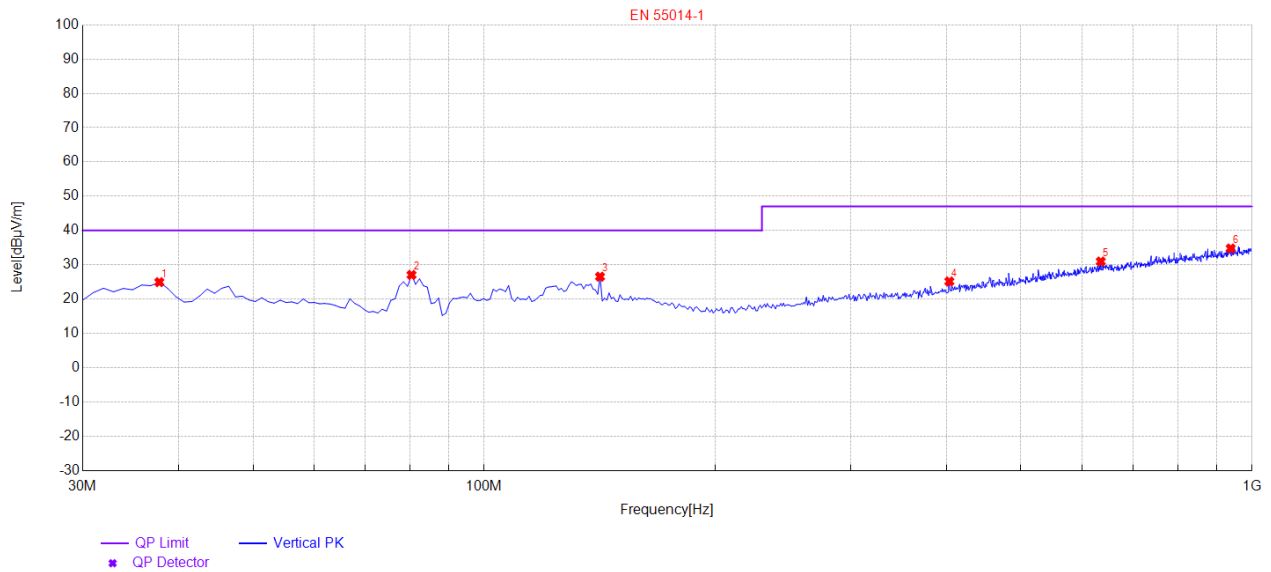

No.	Frequency [MHz]	Level [dBµV/m]	Factor dB	Limit [dBµV/m]	Margin dB	Detector	Polarity
1	37.76	24.94	14.39	40.00	15.06	peak	Vertical
2	80.44	27.05	10.90	40.00	12.95	peak	Vertical
3	141.55	26.54	15.11	40.00	13.46	peak	Vertical
4	403.45	25.15	18.85	47.00	21.85	peak	Vertical
5	635.28	30.96	24.46	47.00	16.04	peak	Vertical
6	937.92	34.77	29.04	47.00	12.23	peak	Vertical

Any report having not been signed by authorized approver, or having been altered without authorization, or having not been stamped by the "Dedicated Testing/Inspection Stamp" is deemed to be invalid. Copying or excerpting portion of, or altering the content of the report is not permitted without the written authorization of AGC. The test results presented in the report apply only to the tested sample. Any objections to report issued by AGC should be submitted to AGC within 15days after the issuance of the test report. Further enquiry of validity or verification of the test report should be addressed to AGC by agc01@agccert.com.

7. Measurement of Harmonic Current Emissions

7.1. Requirements

Applicable test standard(s): EN IEC 61000-3-2:2019+A1:2021+A2:2024

Limits of Harmonic Current Emissions

Harmonic order <i>h</i>	Limits				
	Class A	Class B	Class C ^a	Class D	
	Maximum permissible harmonic current (A)		Maximum permissible harmonic current expressed as a percentage of the input current at the fundamental frequency (%)	Maximum permissible harmonic current per watt (mA/W)	Maximum permissible harmonic current (A)
3	2.30	3.45	27 ^b	3.4	2.30
5	1.14	1.71	10	1.9	1.14
7	0.77	1.155	7	1.0	0.77
9	0.40	0.6	5	0.5	0.40
11	0.33	0.495	3	0.35	0.33
13	0.21	0.315	3	3.85/13	0.21
15 ≤ <i>h</i> ≤ 39 (odd harmonics only)	2.25/ <i>h</i>	3.375/ <i>h</i>	3	3.85/ <i>h</i>	2.25/ <i>h</i>
2	1.08	1.62	2	Not applicable	Not applicable
4	0.43	0.645	Not applicable		
6	0.30	0.45			
8 ≤ <i>h</i> ≤ 40 (even harmonics only)	1.84/ <i>h</i>	2.76/ <i>h</i>			

Note:
 (a) For some Class C products, other emission limits apply.
 (b) The limit is determined based on the assumption of modern lighting technologies having power factors of 0.90 or higher.

The application of limits had been as defined in the applicable test standard.

7.2. Block Diagram of Test Setup

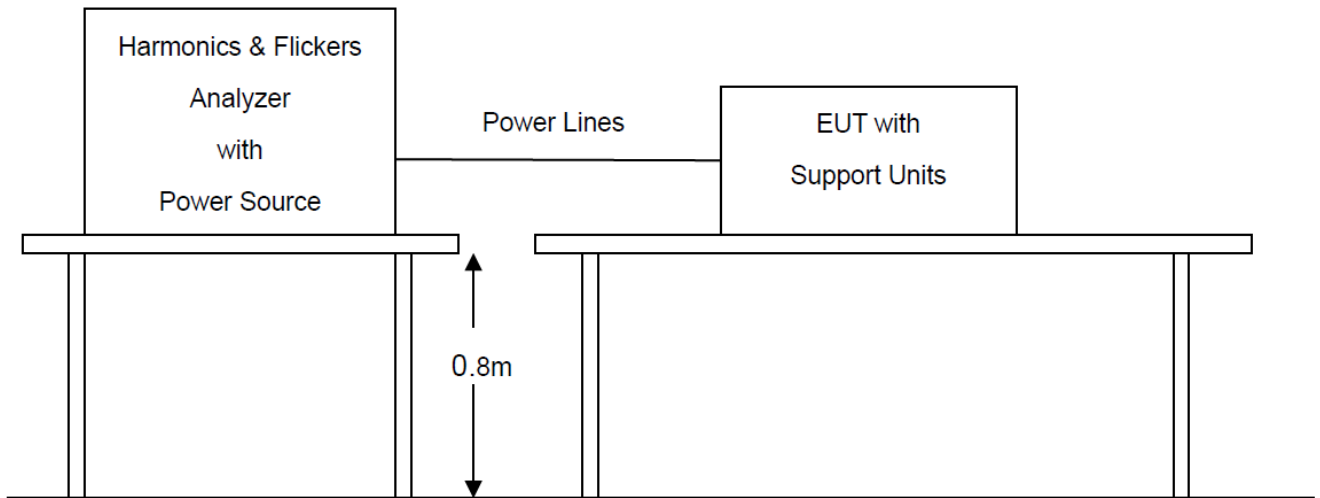

7.3. Equipment Details

Measuring Instruments

Instruments No.	Instruments	Manufacturer	Model	S/N	Cal. Date	Cal. Due
AGC-EM-E033	Signal Conditioning Unit	Schaffner	CCN1000-1	72431	2025-05-16	2026-05-15
AGC-EM-E015	AC Source	Schaffner	NSG 1007	56825	2025-05-16	2026-05-15

Measuring Software

Software No.	Software Name	Manufacturer	Details
AGC-EM-S005	CTS 4	AMETEK	For Harmonics And Flickers Measurement, Version 4.29.0

7.4. Configuration of the EUT and method of measurement

- a. The test shall be conducted according to the general requirements given in the applicable test standard. The test duration had been as defined in the applicable test standard.
- b. The measurement of harmonic currents shall be performed as follows:
 - for each harmonic order, measure the 1.5 s smoothed RMS harmonic current in each discrete Fourier transform (DFT) time window;
 - calculate the arithmetic average of the measured values from the DFT time windows, over the entire observation period.
- c. The value of the active input power to be used for the calculation of limits shall be determined as follows:
 - measure the 1.5 s smoothed active input power in each DFT time window;
 - determine the maximum of the measured values of active power from the DFT time windows over the entire duration of the test.

Any report having not been signed by authorized approver, or having been altered without authorization, or having not been stamped by the "Dedicated Testing/Inspection Stamp" is deemed to be invalid. Copying or excerpting portion of, or altering the content of the report is not permitted without the written authorization of AGC. The test results presented in the report apply only to the tested sample. Any objections to report issued by AGC should be submitted to AGC within 15days after the issuance of the test report. Further enquiry of validity or verification of the test report should be addressed to AGC by agc01@agccert.com.

- d. The harmonic currents and the active input power shall be measured under the same test conditions but need not be measured simultaneously.

7.5. Test Summary

Equipment with a rated power less than or equal to 75W is deemed to fulfil all relevant requirements of this standard without testing.

Any report having not been signed by authorized approver, or having been altered without authorization, or having not been stamped by the “Dedicated Testing/Inspection Stamp” is deemed to be invalid. Copying or excerpting portion of, or altering the content of the report is not permitted without the written authorization of AGC. The test results presented in the report apply only to the tested sample. Any objections to report issued by AGC should be submitted to AGC within 15days after the issuance of the test report. Further enquiry of validity or verification of the test report should be addressed to AGC by agc01@agccert.com.

Attestation of Global Compliance(Shenzhen)Co., Ltd
Attestation of Global Compliance(Shenzhen)Std & Tech Co., Ltd
Tel: +86-755 2523 4088 E-mail: agc@agccert.com Web: <http://www.agccert.com/>

8. Measurement of Voltage Fluctuations and Flicker

8.1. Requirements

Applicable test standard(s): EN 61000-3-3:2013+A1:2019+A2:2021

Limits of Voltage Fluctuations and Flicker

Parameters	Definitions	Limits
T_{max}	the accumulated time value of $d(t)$ with a deviation exceeding 3.3 % during a single voltage change at the EUT terminals	≤ 500 ms
d_c	the maximum relative steady-state voltage change	$\leq 3.3\%$
d_{max}	the maximum relative voltage change	<input checked="" type="checkbox"/> $\leq 4\%$ <input type="checkbox"/> $\leq 6\%$ <input type="checkbox"/> $\leq 7\%$
<input checked="" type="checkbox"/> P_{st}	short-term flicker severity	≤ 1.0
<input type="checkbox"/> P_{lt}	long-term flicker severity	≤ 0.65

8.2. Block Diagram of Test Setup

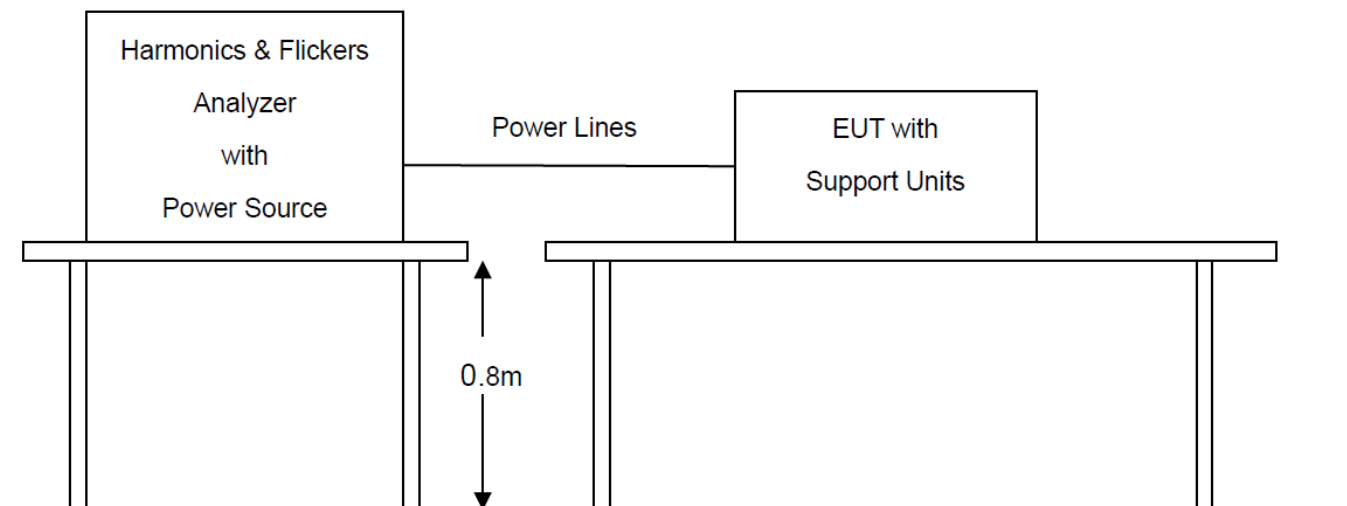

8.3. Equipment Details

Measuring Instruments

Instruments No.	Instruments	Manufacturer	Model	S/N	Cal. Date	Cal. Due
AGC-EM-E033	Signal Conditioning Unit	Schaffner	CCN1000-1	72431	2025-05-16	2026-05-15
AGC-EM-E015	AC Source	Schaffner	NSG 1007	56825	2025-05-16	2026-05-15

Measuring Software

Software No.	Software Name	Manufacturer	Details
AGC-EM-S005	CTS 4	AMETEK	For Harmonics And Flickers Measurement, Version 4.29.0

Any report having not been signed by authorized approver, or having been altered without authorization, or having not been stamped by the "Dedicated Testing/Inspection Stamp" is deemed to be invalid. Copying or excerpting portion of, or altering the content of the report is not permitted without the written authorization of AGC. The test results presented in the report apply only to the tested sample. Any objections to report issued by AGC should be submitted to AGC within 15days after the issuance of the test report. Further enquiry of validity or verification of the test report should be addressed to AGC by agc01@agccert.com.

8.4. Configuration of the EUT and method of measurement

- a. The test shall be conducted according to the general requirements given in the applicable test standard. The test duration and test condition had been as defined in the applicable test standard.
- b. All types of voltage fluctuations would be assessed by direct measurement using a flicker meter which complies with the specification given in IEC 61000-4-15:2010.

8.5. Test Summary

Test Engineer	Kobe Chen	Temperature	21.5°C
Test Date	2025-11-18	Air Pressure	985 Mbar
Worst Mode	Mode 1	Relative Humidity	52.2%
Verdict	Pass		

Parameters	Measurement Value	Limits
T_{max}	0	≤ 500 ms
d_c	0.00	$\leq 3.3\%$
d_{max}	0.00	$\leq 4\%$
P_{st}	0.248	≤ 1.0

Any report having not been signed by authorized approver, or having been altered without authorization, or having not been stamped by the "Dedicated Testing/Inspection Stamp" is deemed to be invalid. Copying or excerpting portion of, or altering the content of the report is not permitted without the written authorization of AGC. The test results presented in the report apply only to the tested sample. Any objections to report issued by AGC should be submitted to AGC within 15days after the issuance of the test report. Further enquiry of validity or verification of the test report should be addressed to AGC by agc01@agccert.com.

9. Measurement of Electrostatic discharge

9.1. Requirements

Port	Enclosure
Basic Standard	IEC 61000-4-2
Test Level	±8.0 kV (Air Discharge) ±4.0 kV (Contact Discharge) ±4.0 kV (Indirect Discharge)
Required Performance Criterion	B
Time Between Each Discharge	1 second
Number of Discharge for Each Applied Voltage	10

9.2. Block Diagram of Test Setup

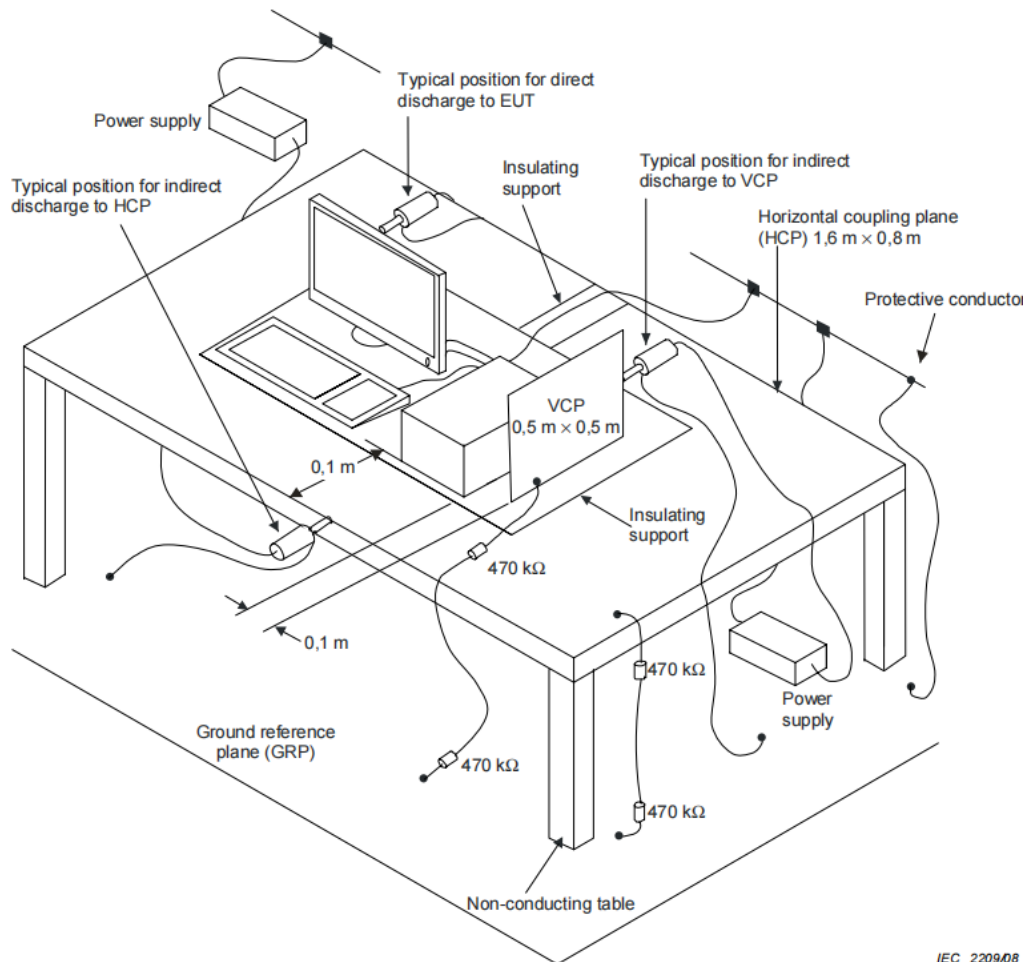

IEC 2209/08

Any report having not been signed by authorized approver, or having been altered without authorization, or having not been stamped by the "Dedicated Testing/Inspection Stamp" is deemed to be invalid. Copying or excerpting portion of, or altering the content of the report is not permitted without the written authorization of AGC. The test results presented in the report apply only to the tested sample. Any objections to report issued by AGC should be submitted to AGC within 15 days after the issuance of the test report. Further enquiry of validity or verification of the test report should be addressed to AGC by agc01@agccert.com.

9.3. Equipment Details

Measuring Instruments

Instruments No.	Instruments	Manufacturer	Model	S/N	Cal. Date	Cal. Due
AGC-EM-E013	ESD Simulator	Schaffner	NSG 438	782	2025-11-03	2026-11-02

Measuring Software

Software No.	Software Name	Manufacturer	Details
--	--	--	--

9.4. Configuration of the EUT and method of measurement

- a. Electrostatic discharges were applied only to those points and surfaces of the EUT that are accessible to users during normal operation.
- b. The test was performed with at least ten single discharges on the pre-selected points in the most sensitive polarity.
- c. The time interval between two successive single discharges was at least 1 second.
- d. The ESD generator was held perpendicularly to the surface to which the discharge was applied and the return cable was at least 0.2 meters from the EUT.
- e. Contact discharges were applied to the non-insulating coating, with the pointed tip of the generator penetrating the coating and contacting the conducting substrate.
- f. Air discharges were applied with the round discharge tip of the discharge electrode approaching the EUT as fast as possible (without causing mechanical damage) to touch the EUT. After each discharge, the ESD generator was removed from the EUT and re-triggered for a new single discharge. The test was repeated until all discharges were completed.
- g. At least ten single discharges (in the most sensitive polarity) were applied to the Horizontal Coupling Plane at points on each side of the EUT. The ESD generator was positioned vertically at a distance of 0.1 meters from the EUT with the discharge electrode touching the HCP.
- h. At least ten single discharges (in the most sensitive polarity) were applied to the center of one vertical edge of the Vertical Coupling Plane in sufficiently different positions that the four faces of the EUT were completely illuminated. The VCP (dimensions 0.5m×0.5m) was placed vertically to and 0.1 meters from the EUT.
- i. The test results shall be classified in terms of the loss of function or degradation of performance of the equipment under test, relative to a performance criterion defined in the report.

Any report having not been signed by authorized approver, or having been altered without authorization, or having not been stamped by the "Dedicated Testing/Inspection Stamp" is deemed to be invalid. Copying or excerpting portion of, or altering the content of the report is not permitted without the written authorization of AGC. The test results presented in the report apply only to the tested sample. Any objections to report issued by AGC should be submitted to AGC within 15days after the issuance of the test report. Further enquiry of validity or verification of the test report should be addressed to AGC by agc01@agccert.com.

9.5. Test Summary

Test Engineer	Jimu Lao	Temperature	18.2 °C
Test Date	2025-11-19	Air Pressure	985 Mbar
Test Mode(s)	Mode 1/2	Relative Humidity	48.2 %
Verdict	Pass		

Voltage	Coupling	Observation	Performance
±4kV	Contact Discharge	No degradation of performance	A
±2KV, ±4kV, ±8kV	Air Discharge	No degradation of performance	A
±4kV	Indirect Discharge HCP	No degradation of performance	A
±4kV	Indirect Discharge VCP	No degradation of performance	A

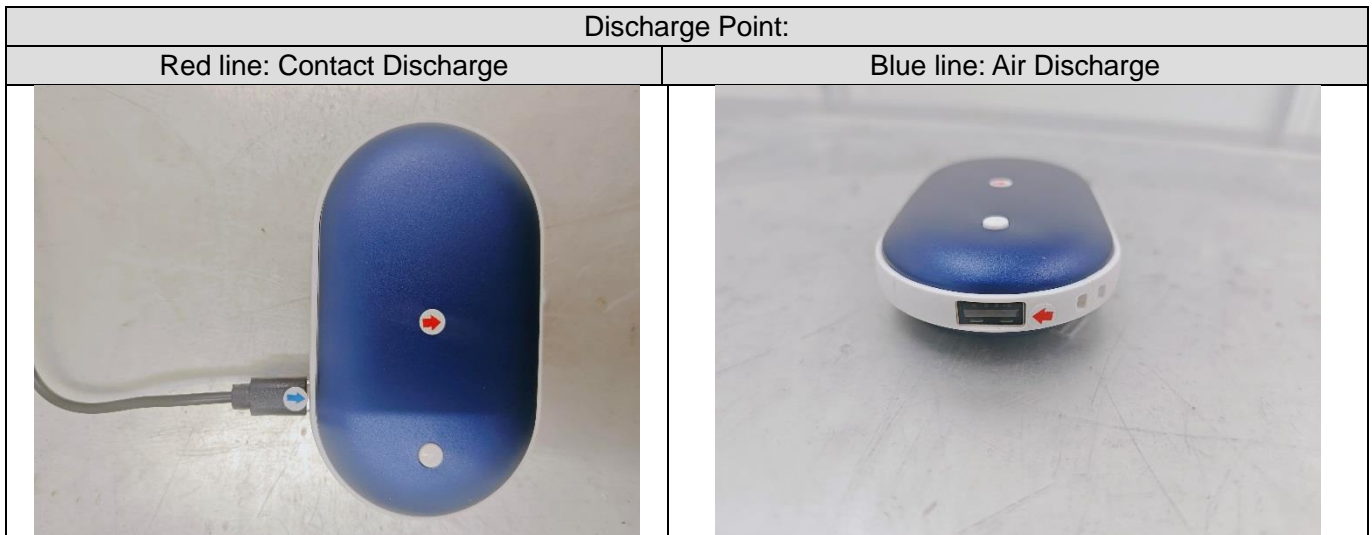

Any report having not been signed by authorized approver, or having been altered without authorization, or having not been stamped by the “Dedicated Testing/Inspection Stamp” is deemed to be invalid. Copying or excerpting portion of, or altering the content of the report is not permitted without the written authorization of AGC. The test results presented in the report apply only to the tested sample. Any objections to report issued by AGC should be submitted to AGC within 15days after the issuance of the test report. Further enquiry of validity or verification of the test report should be addressed to AGC by agc01@agccert.com.

10. Measurement of Radio-Frequency Electromagnetic Field

10.1. Requirements

Port	Enclosure
Basic Standard	IEC 61000-4-3
Test Level	3V/m with 80% AM. 1kHz Modulation at 80 to 1000MHz
Required Performance Criterion	A
Antenna polarization	Vertical and Horizontal
Step size increment ^a	1%
Dwell time ^b	≤5 seconds
Test Distance	3m
EUT position facing antenna	Front side, back side, left side and right side

Notes:

- a. Recognizing that a 1% step size is preferred, the frequency range can be swept incrementally with a step size not exceeding 4% of the previous frequency with a test level of twice the value of the specified test level in order to reduce the testing time for equipment requiring testing in multiple configurations and/or long cycle times.
- b. The dwell time at each frequency shall not be less than the time necessary for the EUT to be exercised and to be able to respond. However, the dwell time shall not exceed 5 seconds at each of the frequencies during the scan. The time to exercise the EUT is not interpreted as a total time of a program or a cycle but related to the reaction time in case of failure of the EUT.

Any report having not been signed by authorized approver, or having been altered without authorization, or having not been stamped by the “Dedicated Testing/Inspection Stamp” is deemed to be invalid. Copying or excerpting portion of, or altering the content of the report is not permitted without the written authorization of AGC. The test results presented in the report apply only to the tested sample. Any objections to report issued by AGC should be submitted to AGC within 15days after the issuance of the test report. Further enquiry of validity or verification of the test report should be addressed to AGC by agc01@agccert.com.

10.2. Block Diagram of Test Setup

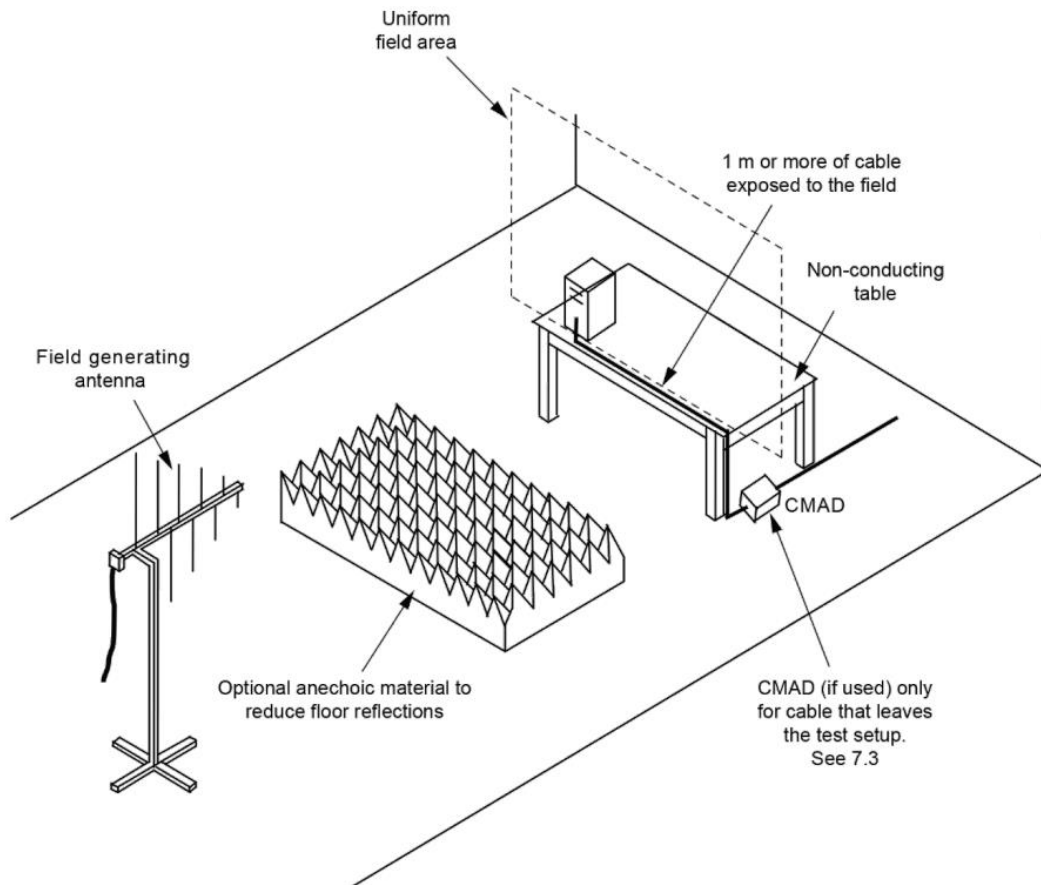

Any report having not been signed by authorized approver, or having been altered without authorization, or having not been stamped by the “Dedicated Testing/Inspection Stamp” is deemed to be invalid. Copying or excerpting portion of, or altering the content of the report is not permitted without the written authorization of AGC. The test results presented in the report apply only to the tested sample. Any objections to report issued by AGC should be submitted to AGC within 15days after the issuance of the test report. Further enquiry of validity or verification of the test report should be addressed to AGC by agc01@agccert.com.

10.3. Equipment Details

Measuring Instruments

Instruments No.	Instruments	Manufacturer	Model	S/N	Cal. Date	Cal. Due
AGC-EM-E115	Signal Generator	Aglient	N5182A	MY49060745	2025-03-07	2026-03-06
AGC-EM-E040	Directional Couple	Werlatonee	C5571-10	99463	2024-02-01	2026-01-31
AGC-EM-E035	Power Probe	R&S	URV5-Z4	100124	2025-03-24	2027-03-23
AGC-EM-E005	Power Meter	R&S	NRVD	8323781027	2025-03-24	2027-03-23
AGC-EM-E016	Power Amplifier	KALMUS	7100LC	04-02/17-06-001	2025-07-18	2026-07-17
AGC-EM-E028	Wideband Antenna	ETS-LINDGREN	3142C	00060447	N/A	N/A

Measuring Software

Software No.	Software Name	Manufacturer	Details
AGC-EM-S006	TS+[JS35-RS]	Tonscend	For EMC Measurement, Version 2.0.1.8

10.4. Configuration of the EUT and method of measurement

- a. The Equipment Under Test (EUT) was positioned within the Uniform Field Area (UFA) on a supporting table, ensuring a 3-meter separation from the transmitting antenna. This setup aligns with the calibrated square area, guaranteeing field uniformity during testing. The supporting units were strategically located outside the UFA to avoid any potential interference. Nonetheless, the cables connected to the EUT were intentionally exposed to the precisely calibrated field within the UFA.
- b. Before testing, it will verify the proper operation of the test equipment/system. This verification will involve measuring the field strength at one point within the Uniform Field Area (UFA) at various frequencies.
- c. The test shall be performed according to the above requirements and block diagram which shall specify the test setup.
- d. The test results shall be classified in terms of the loss of function or degradation of performance of the equipment under test, relative to a performance criterion defined in the report.

Any report having not been signed by authorized approver, or having been altered without authorization, or having not been stamped by the "Dedicated Testing/Inspection Stamp" is deemed to be invalid. Copying or excerpting portion of, or altering the content of the report is not permitted without the written authorization of AGC. The test results presented in the report apply only to the tested sample. Any objections to report issued by AGC should be submitted to AGC within 15days after the issuance of the test report. Further enquiry of validity or verification of the test report should be addressed to AGC by agc01@agccert.com.

10.5. Test Summary

Test Engineer	Tom Chen	Temperature	22.4°C
Test Date	2025-11-17	Air Pressure	985 Mbar
Test Mode(s)	Mode 1/2	Relative Humidity	54.8 %
Verdict	Pass		

Frequency	Exposed Side	Field Strength (V/m)	Observation	Performance
80MHz to 1GHz	Front	3V/m (rms)	No degradation of performance	A
	Left		No degradation of performance	A
	Rear		No degradation of performance	A
	Right		No degradation of performance	A

Any report having not been signed by authorized approver, or having been altered without authorization, or having not been stamped by the “Dedicated Testing/Inspection Stamp” is deemed to be invalid. Copying or excerpting portion of, or altering the content of the report is not permitted without the written authorization of AGC. The test results presented in the report apply only to the tested sample. Any objections to report issued by AGC should be submitted to AGC within 15days after the issuance of the test report. Further enquiry of validity or verification of the test report should be addressed to AGC by agc01@agccert.com.

11. Measurement of Radio-frequency common mode

11.1. Requirements

Port	<input checked="" type="checkbox"/> AC mains power ports	<input type="checkbox"/> signal, wired network and control ports ^a	<input type="checkbox"/> DC power ports ^a
Basic Standard	IEC 61000-4-6		
Required Performance Criterion	A		
Test Level	3 V RMS (unmodulated), 80 % AM (1 kHz)	1 V RMS (unmodulated), 80 % AM (1 kHz)	1 V RMS (unmodulated), 80 % AM (1 kHz)
Test Frequency	<input checked="" type="checkbox"/> 0.15 to 80 MHz <input type="checkbox"/> 0.15 to 230 MHz		
Step size increment ^b	1%		
Dwell time ^c	≤5 seconds		

Notes:

- Applicable only to ports which, according to the manufacturer’s specification, supports cable lengths greater than 3 m.
- Recognizing that a 1% step size is preferred, the frequency range can be swept incrementally with a step size not exceeding 4% of the previous frequency with a test level of twice the value of the specified test level in order to reduce the testing time for equipment requiring testing in multiple configurations and/or long cycle times.
- The dwell time at each frequency shall not be less than the time necessary for the EUT to be exercised and to be able to respond. However, the dwell time shall not exceed 5 seconds at each of the frequencies during the scan. The time to exercise the EUT is not interpreted as a total time of a program or a cycle but related to the reaction time in case of failure of the EUT.

11.2. Block Diagram of Test Setup

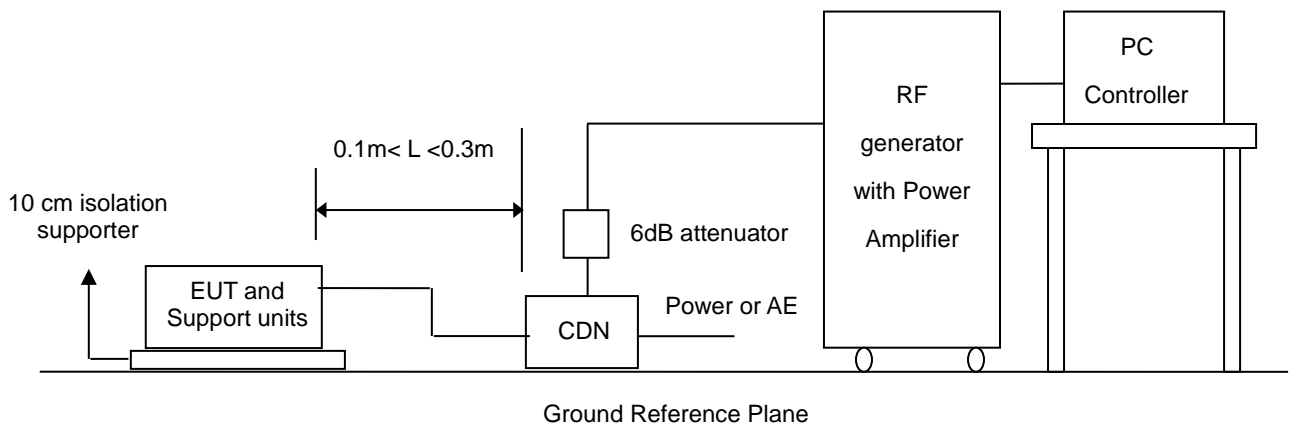

Any report having not been signed by authorized approver, or having been altered without authorization, or having not been stamped by the “Dedicated Testing/Inspection Stamp” is deemed to be invalid. Copying or excerpting portion of, or altering the content of the report is not permitted without the written authorization of AGC. The test results presented in the report apply only to the tested sample. Any objections to report issued by AGC should be submitted to AGC within 15days after the issuance of the test report. Further enquiry of validity or verification of the test report should be addressed to AGC by agc01@agccert.com.

11.3. Equipment Details

Measuring Instruments

Instruments No.	Instruments	Manufacturer	Model	S/N	Cal. Date	Cal. Due
AGC-EM-E017	Power Amplifier	AR	75A250	18464	2025-07-18	2026-07-17
AGC-EM-E161	CDN	3C TEST	CDN M2M3	ES064002624028	2025-09-05	2026-09-04
AGC-EM-A048	Attenuator	ZHINAN	E-002	N/A	2024-07-24	2026-07-23
AGC-EM-E035	Power Probe	R&S	URV5-Z4	100124	2025-03-24	2027-03-23
AGC-EM-E005	Power Meter	R&S	NRVD	8323781027	2025-03-24	2027-03-23
AGC-EM-E040	Directional Coupler	Werlatone	C5571-10	99463	2024-02-01	2026-01-31
AGC-EM-E034	Electromagnetic Injection Clamp	Luthi	EM 101	35773	2024-07-24	2026-07-23
AGC-EM-E115	Signal Generator	Aglient	N5182A	MY49060745	2025-03-07	2026-03-06

Measuring Software

Software No.	Software Name	Manufacturer	Details
AGC-EM-S007	TS+[JS35-CS]	Tonscend	For EMC Measurement, Version 2.0.1.7

11.4. Configuration of the EUT and method of measurement

- a. The Equipment Under Test (EUT) shall be tested within its intended operating and climatic conditions.
- b. The test generator and the coupling/decoupling network shall be placed directly on, and bonded to, the ground reference plane. The test shall be performed with the test generator connected to each of the coupling devices (CDN, EM clamp, current clamp) in turn. All other cables not under test shall either be disconnected (when functionally allowed) or provided with decoupling networks or unterminated CDNs only.
- c. The test shall be performed according to the above requirements and block diagram which shall specify the test setup.
- d. The test results shall be classified in terms of the loss of function or degradation of performance of the equipment under test, relative to a performance criterion defined in the report.

Any report having not been signed by authorized approver, or having been altered without authorization, or having not been stamped by the "Dedicated Testing/Inspection Stamp" is deemed to be invalid. Copying or excerpting portion of, or altering the content of the report is not permitted without the written authorization of AGC. The test results presented in the report apply only to the tested sample. Any objections to report issued by AGC should be submitted to AGC within 15days after the issuance of the test report. Further enquiry of validity or verification of the test report should be addressed to AGC by agc01@agccert.com.

11.5. Test Summary

Test Engineer	Jimu Lao	Temperature	18.2 °C
Test Date	2025-11-15	Air Pressure	985 Mbar
Test Mode(s)	Mode 1	Relative Humidity	48.2 %
Verdict	Pass		

Test port	Test Level	Coupling method	Observation	Performance
AC Mains Input	3 V	CDN	No degradation of performance	A

Any report having not been signed by authorized approver, or having been altered without authorization, or having not been stamped by the “Dedicated Testing/Inspection Stamp” is deemed to be invalid. Copying or excerpting portion of, or altering the content of the report is not permitted without the written authorization of AGC. The test results presented in the report apply only to the tested sample. Any objections to report issued by AGC should be submitted to AGC within 15days after the issuance of the test report. Further enquiry of validity or verification of the test report should be addressed to AGC by agc01@agccert.com.

12. Measurement of Fast Transients

12.1. Requirements

Port	<input checked="" type="checkbox"/> AC mains power ports	<input type="checkbox"/> signal, wired network and control ports ^a	<input type="checkbox"/> DC power ports ^a
Basic Standard	IEC 61000-4-4		
Required Performance Criterion	B		
Test Level	1 kV (peak)	0.5 kV (peak)	0.5 kV (peak)
Polarity	Positive/Negative		
Impulse Frequency	5kHz		
Impulse wave shape	5/50ns		
Burst Duration	15ms		
Burst Period	300ms		
Notes:			
a. Applicable only to ports which, according to the manufacturer's specification, supports cable lengths greater than 3 m.			

12.2. Block Diagram of Test Setup

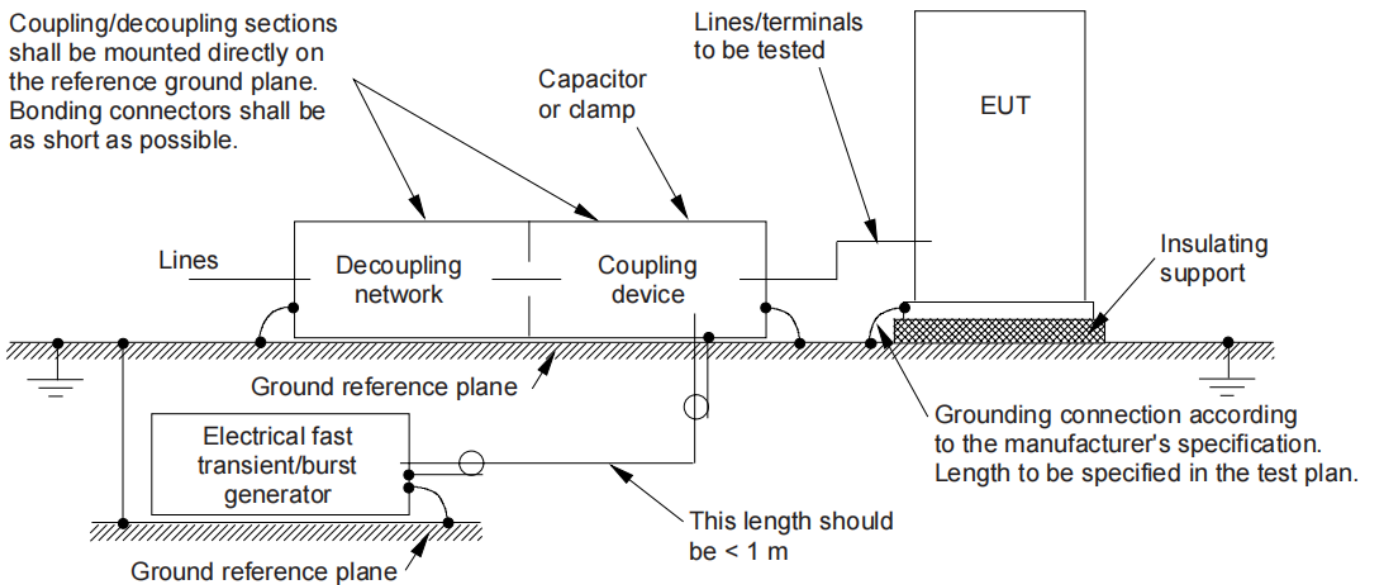

Any report having not been signed by authorized approver, or having been altered without authorization, or having not been stamped by the "Dedicated Testing/Inspection Stamp" is deemed to be invalid. Copying or excerpting portion of, or altering the content of the report is not permitted without the written authorization of AGC. The test results presented in the report apply only to the tested sample. Any objections to report issued by AGC should be submitted to AGC within 15days after the issuance of the test report. Further enquiry of validity or verification of the test report should be addressed to AGC by agc01@agccert.com.

12.3. Equipment Details

Measuring Instruments

Instruments No.	Instruments	Manufacturer	Model	S/N	Cal. Date	Cal. Due
AGC-EM-E008	EFT/Surge/DIPS Generator	Schaffner	Modula 6150	34437	2025-05-08	2026-05-07

Measuring Software

Software No.	Software Name	Manufacturer	Details
AGC-EM-S009	WinModula	Schaffner	For EFT/Surge/Dips Measurement, Version 2.31 c

12.4. Configuration of the EUT and method of measurement

- a. The Equipment Under Test (EUT), whether stationary floor-mounted or table top, and equipment designed to be mounted in other configurations, shall be placed on a ground reference plane and shall be insulated from it by an insulating support 0,1 m ± 0,01 m thick.
- b. The test generator and the coupling/decoupling network shall be placed directly on, and bonded to, the ground reference plane.
- c. The EUT shall be arranged and connected to satisfy its functional requirements, according to the equipment installation specifications. The minimum distance between the EUT and all other conductive structures (e.g. the walls of a shielded room), except the ground reference plane shall be more than 0,5 m. All cables to the EUT shall be placed on the insulation support 0,1 m above the ground reference plane. Cables not subject to electrical fast transients shall be routed as far as possible from the cable under test to minimize the coupling between the cables.
- d. The test voltages shall be coupled to all of the EUT ports including those between two units of equipment involved in the test, unless the length of the interconnecting cable makes it impossible to test.
- e. Either a direct coupling network or a capacitive clamp shall be used for the application of the test voltages.
- f. The test results shall be classified in terms of the loss of function or degradation of performance of the equipment under test, relative to a performance criterion defined in the report.

Any report having not been signed by authorized approver, or having been altered without authorization, or having not been stamped by the "Dedicated Testing/Inspection Stamp" is deemed to be invalid. Copying or excerpting portion of, or altering the content of the report is not permitted without the written authorization of AGC. The test results presented in the report apply only to the tested sample. Any objections to report issued by AGC should be submitted to AGC within 15days after the issuance of the test report. Further enquiry of validity or verification of the test report should be addressed to AGC by agc01@agccert.com.

12.5. Test Summary

Test Engineer	Jimu Lao	Temperature	18.2 °C
Test Date	2025-11-15	Air Pressure	985 Mbar
Test Mode(s)	Mode 1	Relative Humidity	48.2 %
Verdict	Pass		

Inject Line	Voltage(kV)	Inject Method	Observation	Performance
AC Lines	0.5, 1	Direct	No degradation of performance	A

Any report having not been signed by authorized approver, or having been altered without authorization, or having not been stamped by the “Dedicated Testing/Inspection Stamp” is deemed to be invalid. Copying or excerpting portion of, or altering the content of the report is not permitted without the written authorization of AGC. The test results presented in the report apply only to the tested sample. Any objections to report issued by AGC should be submitted to AGC within 15days after the issuance of the test report. Further enquiry of validity or verification of the test report should be addressed to AGC by agc01@agccert.com.

13. Measurement of Surges

13.1. Requirements

Port	<input checked="" type="checkbox"/> AC mains power ports ^a	<input type="checkbox"/> signal, wired network and control ports ^b	<input type="checkbox"/> DC network power ports ^b
Basic Standard	IEC 61000-4-5		
Required Performance Criterion	B	B	B
Test Level	Line to line: 1 kV; Line to ground: 2 kV	shield to ground: 0.5 kV	Line to ground: 0.5 kV
Tr/Th	1.2/50 (8/20) μ s		
Number of impulses	Five positive and five negative impulses		
Time between successive impulses	1 min		

Notes:

- a. The number of pulses applied shall be as follows:
 - Five positive pulses line-to-neutral at 90° phase.
 - Five negative pulses line-to-neutral at 270° phase.
 The following additional pulses are required only if the EUT has an earth connection or if the EUT is earthed via any AE:
 - Five positive pulses line-to-earth at 90° phase.
 - Five negative pulses line-to-earth at 270° phase.
 - Five negative pulses neutral-to-earth at 90° phase.
 - Five positive pulses neutral-to-earth at 270° phase.
- b. Applicable only to ports which, according to the manufacturer’s specification, supports cable lengths greater than 3 m.

13.2. Block Diagram of Test Setup

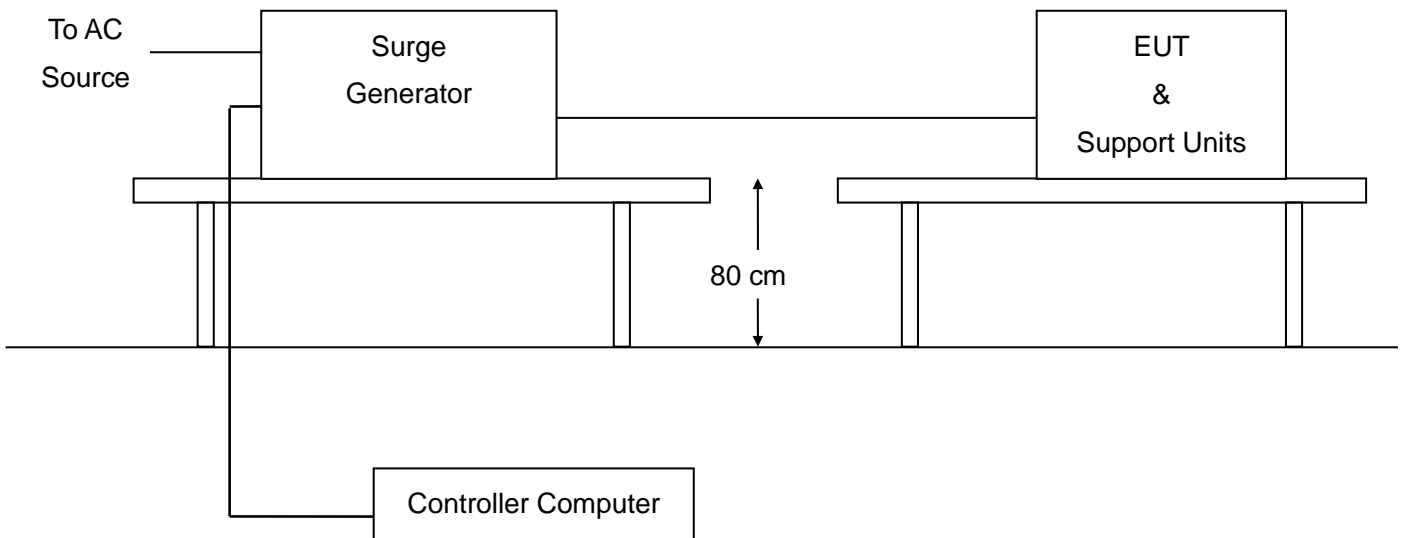

Any report having not been signed by authorized approver, or having been altered without authorization, or having not been stamped by the “Dedicated Testing/Inspection Stamp” is deemed to be invalid. Copying or excerpting portion of, or altering the content of the report is not permitted without the written authorization of AGC. The test results presented in the report apply only to the tested sample. Any objections to report issued by AGC should be submitted to AGC within 15days after the issuance of the test report. Further enquiry of validity or verification of the test report should be addressed to AGC by agc01@agccert.com.

13.3. Equipment Details

Measuring Instruments

Instruments No.	Instruments	Manufacturer	Model	S/N	Cal. Date	Cal. Due
AGC-EM-E008	EFT/Surge/DIPS Generator	Schaffner	Modula 6150	34437	2025-05-08	2026-05-07

Measuring Software

Software No.	Software Name	Manufacturer	Details
AGC-EM-S009	WinModula	Schaffner	For EFT/Surge/Dips Measurement, Version 2.31 c

13.4. Configuration of the EUT and method of measurement

- a. Verification shall be performed. It is preferable to perform the verification prior to the test.
- b. The test shall be performed according to the above requirements and block diagram which shall specify the test setup.
- c. When testing line-to-ground, the lines are tested individually in sequence, if there is no other specification.
- d. The test procedure shall also consider the non-linear current-voltage characteristics of the equipment under test. Therefore, all lower test levels including the selected test level shall be tested.
- e. The test results shall be classified in terms of the loss of function or degradation of performance of the equipment under test, relative to a performance criterion defined in the report.

13.5. Test Summary

Test Engineer	Jimu Lao	Temperature	18.2 °C
Test Date	2025-11-15	Air Pressure	985 Mbar
Test Mode(s)	Mode 1	Relative Humidity	48.2 %
Verdict	Pass		

Test port	Coupling	Voltage(kV)	Observation	Performance
AC Mains Input	line-to-neutral	0.5, 1	No degradation of performance	A

Any report having not been signed by authorized approver, or having been altered without authorization, or having not been stamped by the "Dedicated Testing/Inspection Stamp" is deemed to be invalid. Copying or excerpting portion of, or altering the content of the report is not permitted without the written authorization of AGC. The test results presented in the report apply only to the tested sample. Any objections to report issued by AGC should be submitted to AGC within 15days after the issuance of the test report. Further enquiry of validity or verification of the test report should be addressed to AGC by agc01@agccert.com.

14. Photographs of Test Setup



Conducted emissions from the AC mains power ports

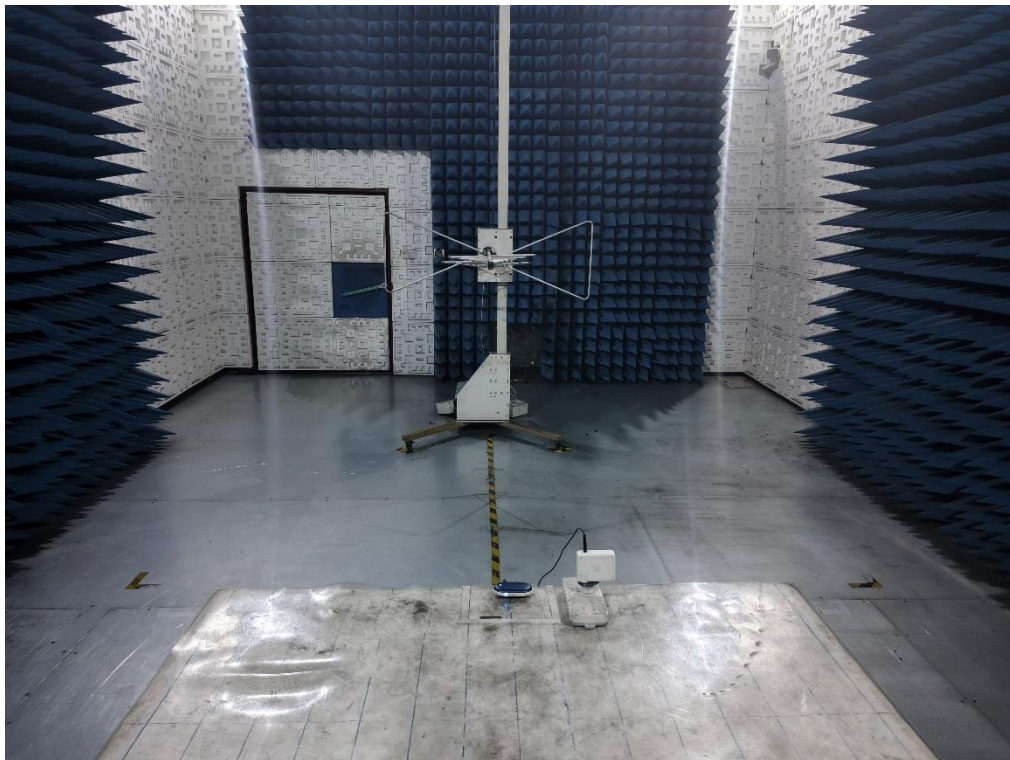

Radiated emissions at frequencies up to 1 GHz

Any report having not been signed by authorized approver, or having been altered without authorization, or having not been stamped by the “Dedicated Testing/Inspection Stamp” is deemed to be invalid. Copying or excerpting portion of, or altering the content of the report is not permitted without the written authorization of AGC. The test results presented in the report apply only to the tested sample. Any objections to report issued by AGC should be submitted to AGC within 15days after the issuance of the test report. Further enquiry of validity or verification of the test report should be addressed to AGC by agc01@agccert.com.



Harmonic current emissions & Voltage fluctuations and flicker

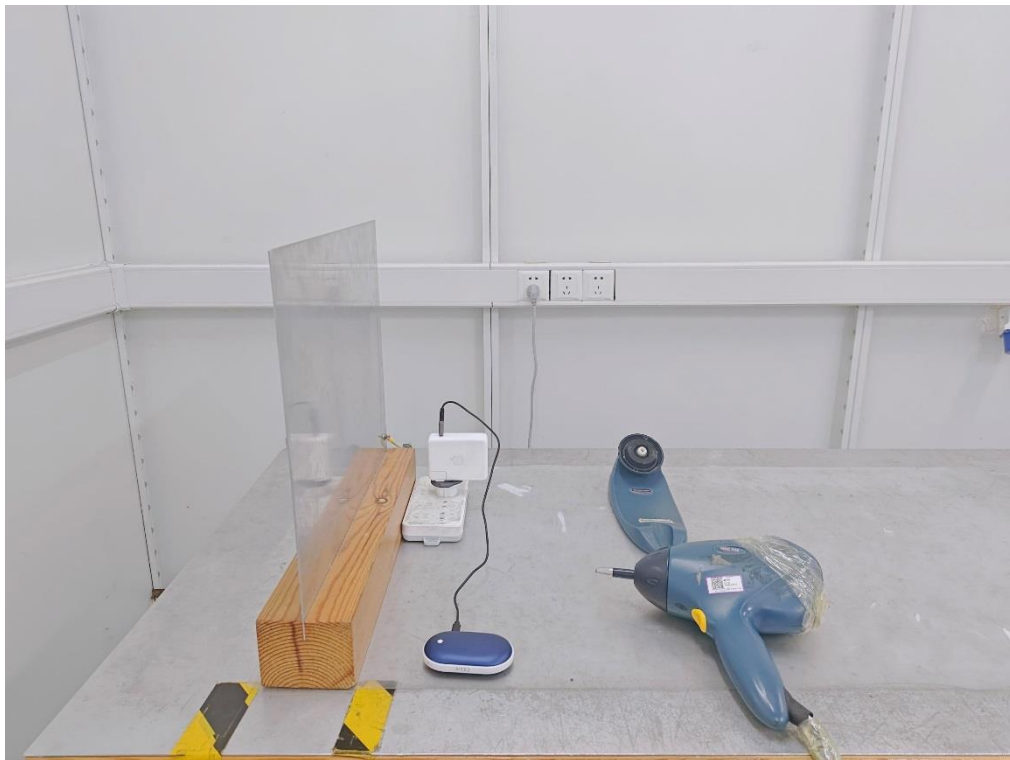

Electrostatic discharge

Any report having not been signed by authorized approver, or having been altered without authorization, or having not been stamped by the “Dedicated Testing/Inspection Stamp” is deemed to be invalid. Copying or excerpting portion of, or altering the content of the report is not permitted without the written authorization of AGC. The test results presented in the report apply only to the tested sample. Any objections to report issued by AGC should be submitted to AGC within 15days after the issuance of the test report. Further enquiry of validity or verification of the test report should be addressed to AGC by agc01@agccert.com.

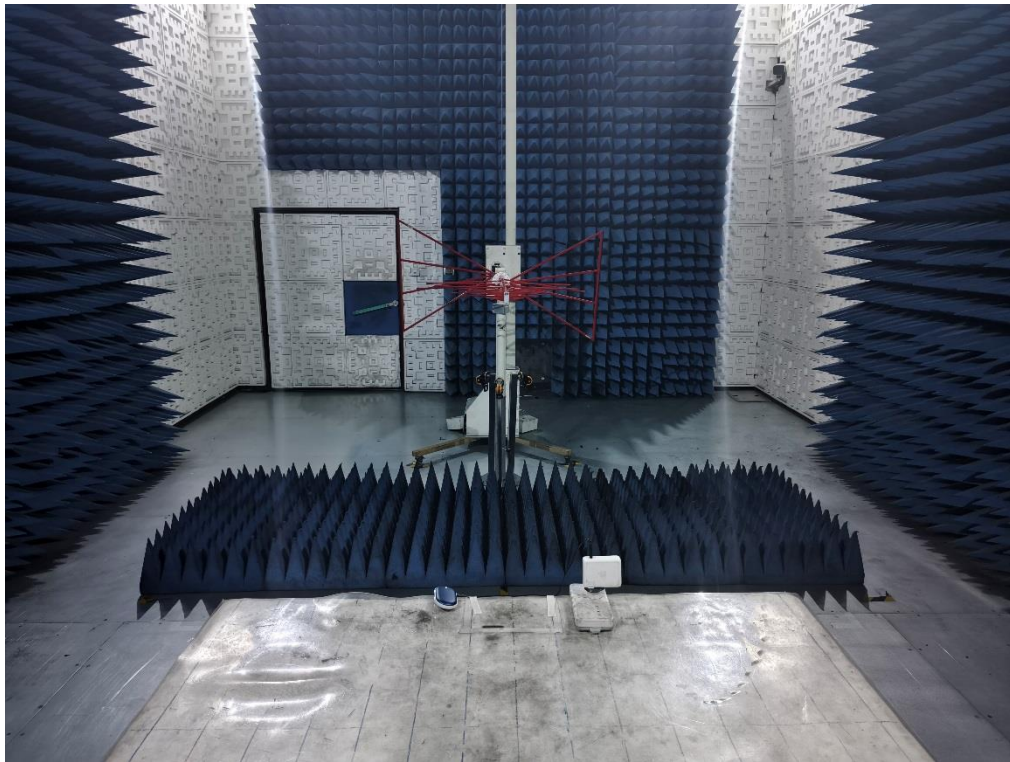

Radio-Frequency Electromagnetic Field up to 1 GHz

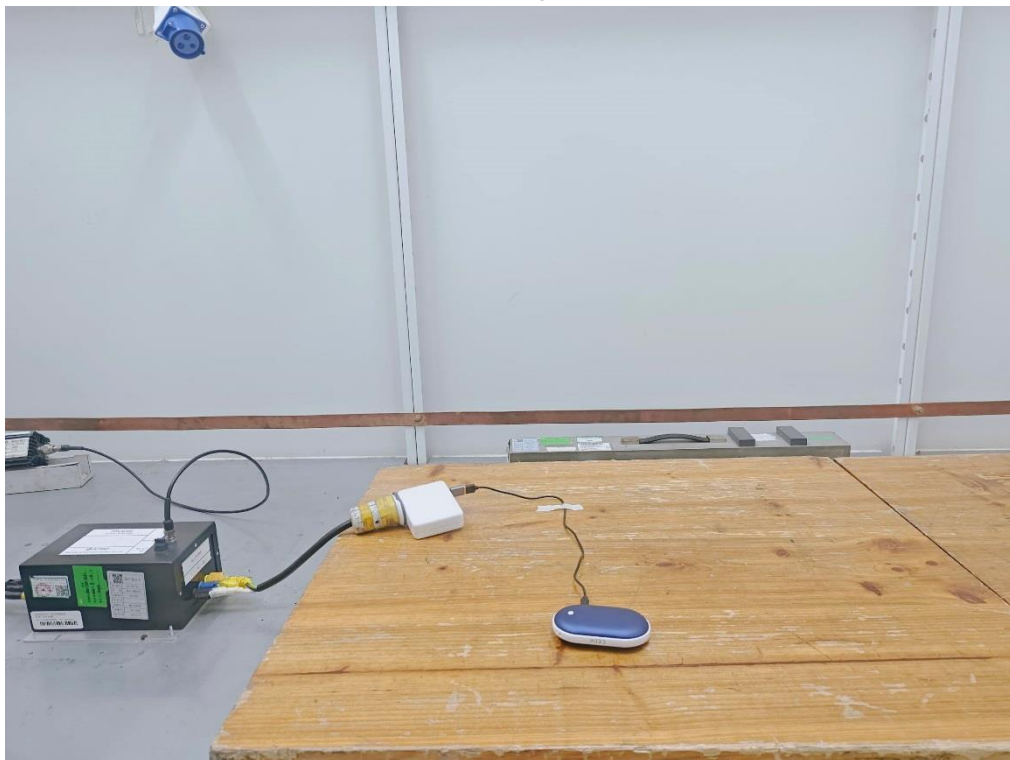

Radio-frequency common mode at the AC mains power ports

Any report having not been signed by authorized approver, or having been altered without authorization, or having not been stamped by the “Dedicated Testing/Inspection Stamp” is deemed to be invalid. Copying or excerpting portion of, or altering the content of the report is not permitted without the written authorization of AGC. The test results presented in the report apply only to the tested sample. Any objections to report issued by AGC should be submitted to AGC within 15days after the issuance of the test report. Further enquiry of validity or verification of the test report should be addressed to AGC by agc01@agccert.com.



Fast transients/Surges/ Voltage dips at the AC mains power ports

Any report having not been signed by authorized approver, or having been altered without authorization, or having not been stamped by the "Dedicated Testing/Inspection Stamp" is deemed to be invalid. Copying or excerpting portion of, or altering the content of the report is not permitted without the written authorization of AGC. The test results presented in the report apply only to the tested sample. Any objections to report issued by AGC should be submitted to AGC within 15days after the issuance of the test report. Further enquiry of validity or verification of the test report should be addressed to AGC by agc01@agccert.com.

Attestation of Global Compliance(Shenzhen)Co., Ltd
Attestation of Global Compliance(Shenzhen)Std & Tech Co., Ltd
Tel: +86-755 2523 4088 E-mail: agc@agccert.com Web: <http://www.agccert.com/>

15. Photographs of EUT



All view-1 of EUT



All view-2 of EUT

Any report having not been signed by authorized approver, or having been altered without authorization, or having not been stamped by the “Dedicated Testing/Inspection Stamp” is deemed to be invalid. Copying or excerpting portion of, or altering the content of the report is not permitted without the written authorization of AGC. The test results presented in the report apply only to the tested sample. Any objections to report issued by AGC should be submitted to AGC within 15days after the issuance of the test report. Further enquiry of validity or verification of the test report should be addressed to AGC by agc01@agccert.com.



All view-3 of EUT



All view-4 of EUT

Any report having not been signed by authorized approver, or having been altered without authorization, or having not been stamped by the “Dedicated Testing/Inspection Stamp” is deemed to be invalid. Copying or excerpting portion of, or altering the content of the report is not permitted without the written authorization of AGC. The test results presented in the report apply only to the tested sample. Any objections to report issued by AGC should be submitted to AGC within 15days after the issuance of the test report. Further enquiry of validity or verification of the test report should be addressed to AGC by agc01@agccert.com.

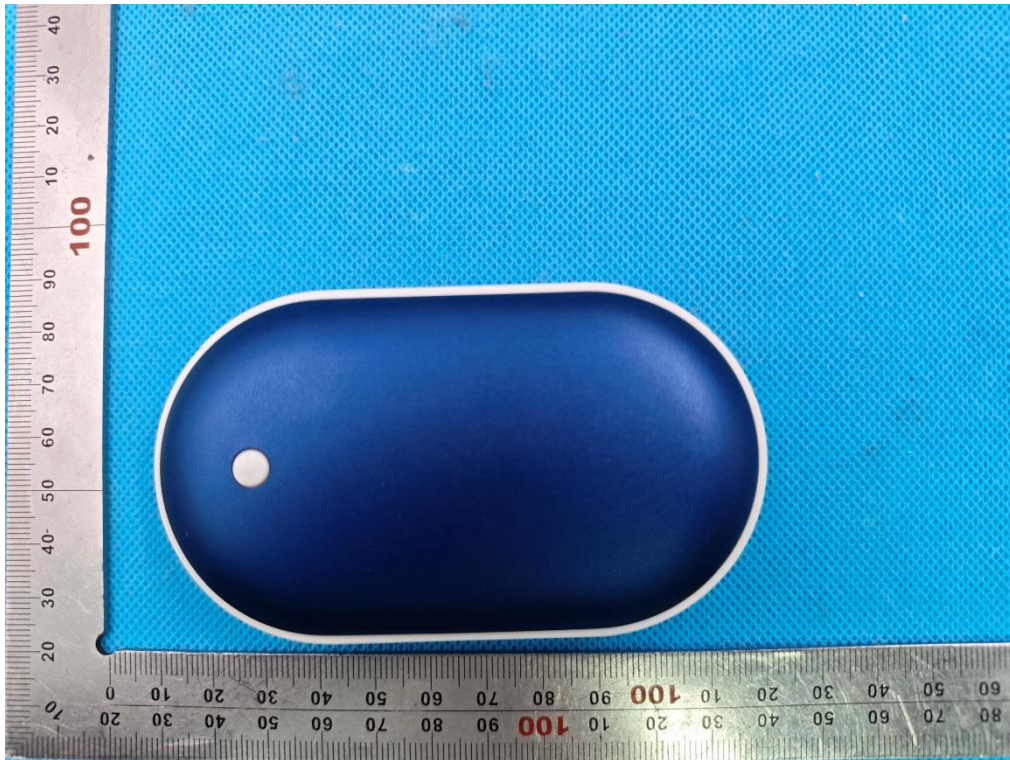

Top view of EUT

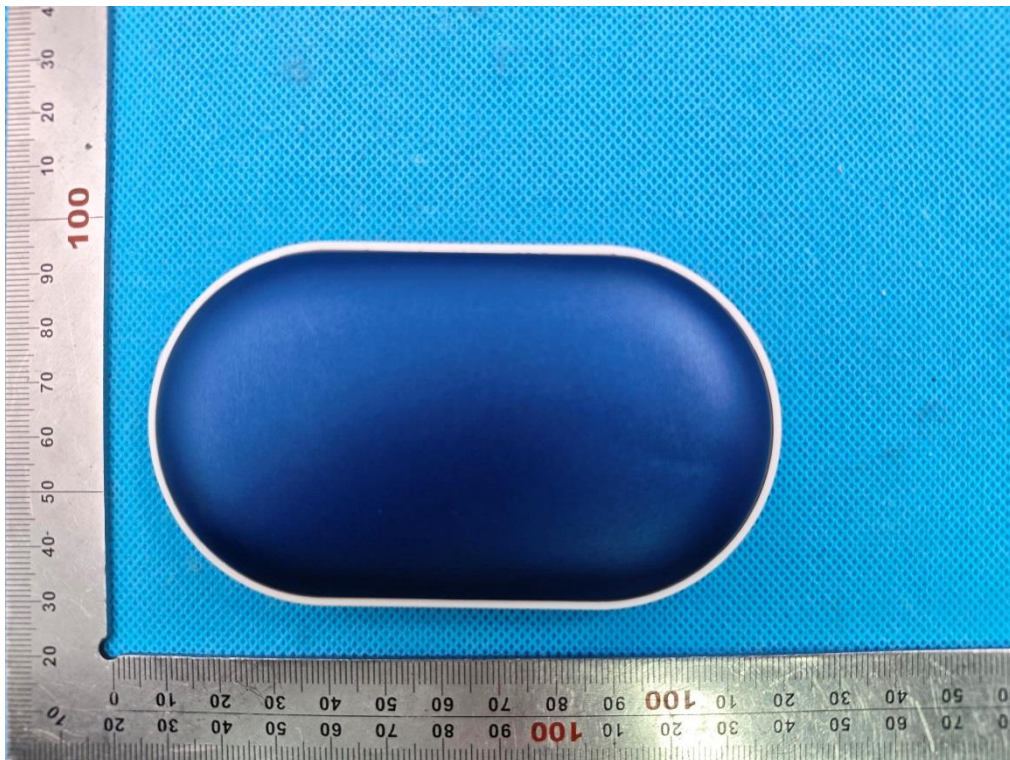

Bottom view of EUT

Any report having not been signed by authorized approver, or having been altered without authorization, or having not been stamped by the “Dedicated Testing/Inspection Stamp” is deemed to be invalid. Copying or excerpting portion of, or altering the content of the report is not permitted without the written authorization of AGC. The test results presented in the report apply only to the tested sample. Any objections to report issued by AGC should be submitted to AGC within 15days after the issuance of the test report. Further enquiry of validity or verification of the test report should be addressed to AGC by agc01@agccert.com.



Front view of EUT



Back view of EUT

Any report having not been signed by authorized approver, or having been altered without authorization, or having not been stamped by the “Dedicated Testing/Inspection Stamp” is deemed to be invalid. Copying or excerpting portion of, or altering the content of the report is not permitted without the written authorization of AGC. The test results presented in the report apply only to the tested sample. Any objections to report issued by AGC should be submitted to AGC within 15days after the issuance of the test report. Further enquiry of validity or verification of the test report should be addressed to AGC by agc01@agccert.com.

Attestation of Global Compliance(Shenzhen)Co., Ltd
Attestation of Global Compliance(Shenzhen)Std & Tech Co., Ltd
Tel: +86-755 2523 4088 E-mail: agc@agccert.com Web: <http://www.agccert.com/>



Left view of EUT



Right view of EUT

Any report having not been signed by authorized approver, or having been altered without authorization, or having not been stamped by the “Dedicated Testing/Inspection Stamp” is deemed to be invalid. Copying or excerpting portion of, or altering the content of the report is not permitted without the written authorization of AGC. The test results presented in the report apply only to the tested sample. Any objections to report issued by AGC should be submitted to AGC within 15days after the issuance of the test report. Further enquiry of validity or verification of the test report should be addressed to AGC by agc01@agccert.com.

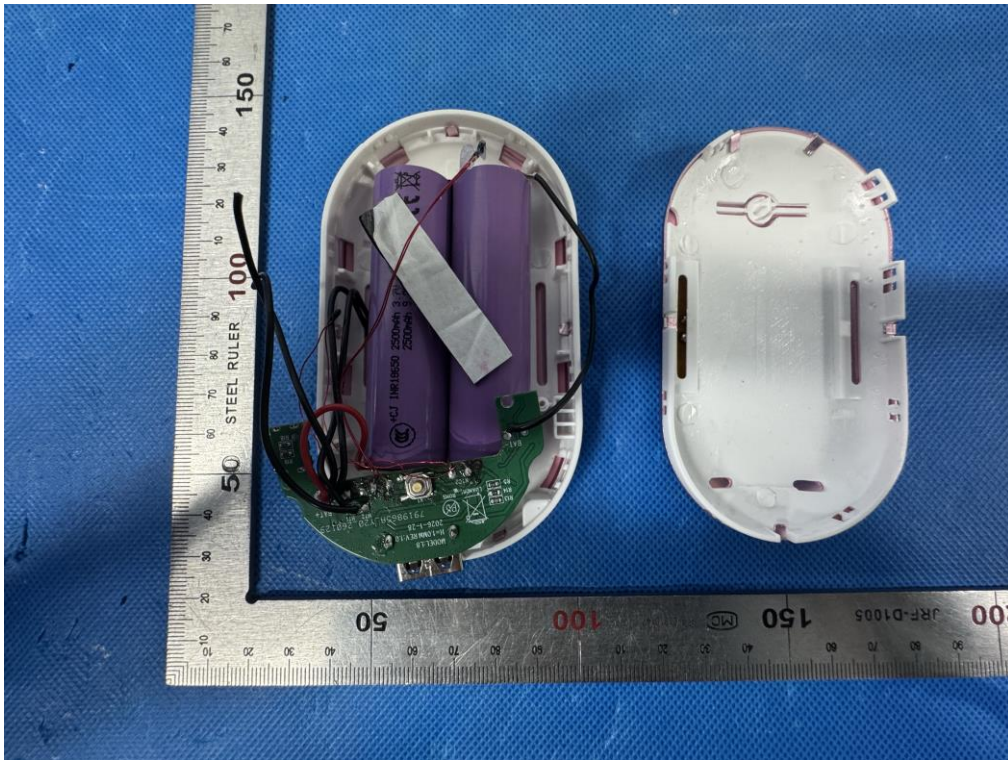

Open view of EUT

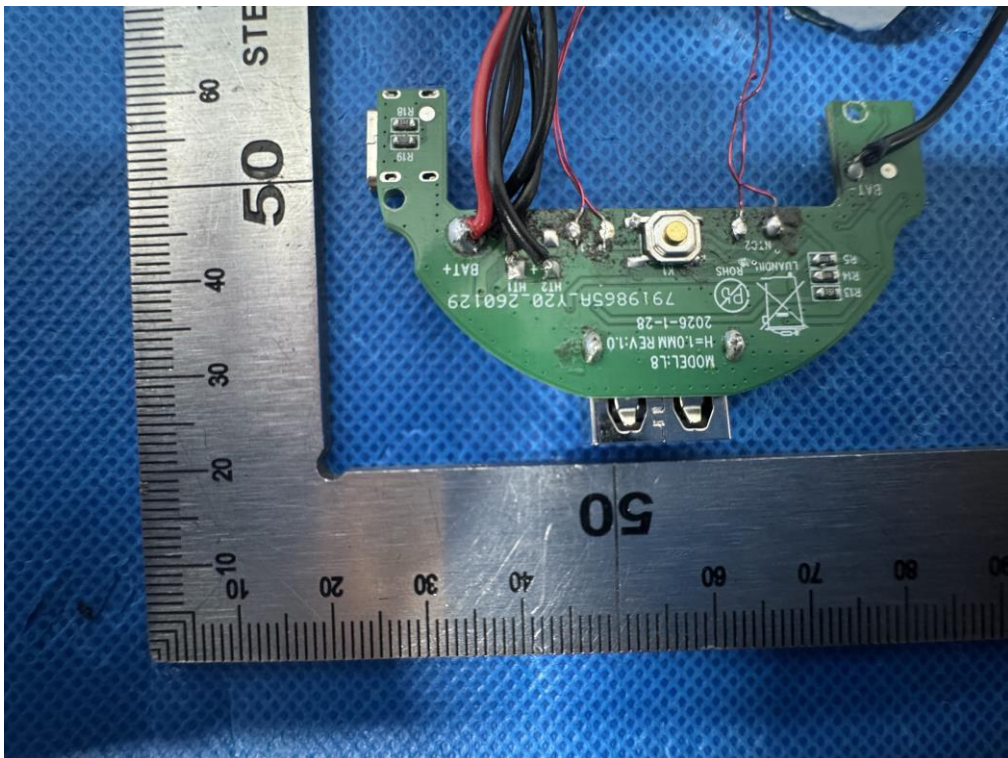

Internal view-1 of EUT

Any report having not been signed by authorized approver, or having been altered without authorization, or having not been stamped by the "Dedicated Testing/Inspection Stamp" is deemed to be invalid. Copying or excerpting portion of, or altering the content of the report is not permitted without the written authorization of AGC. The test results presented in the report apply only to the tested sample. Any objections to report issued by AGC should be submitted to AGC within 15days after the issuance of the test report. Further enquiry of validity or verification of the test report should be addressed to AGC by agc01@agccert.com.

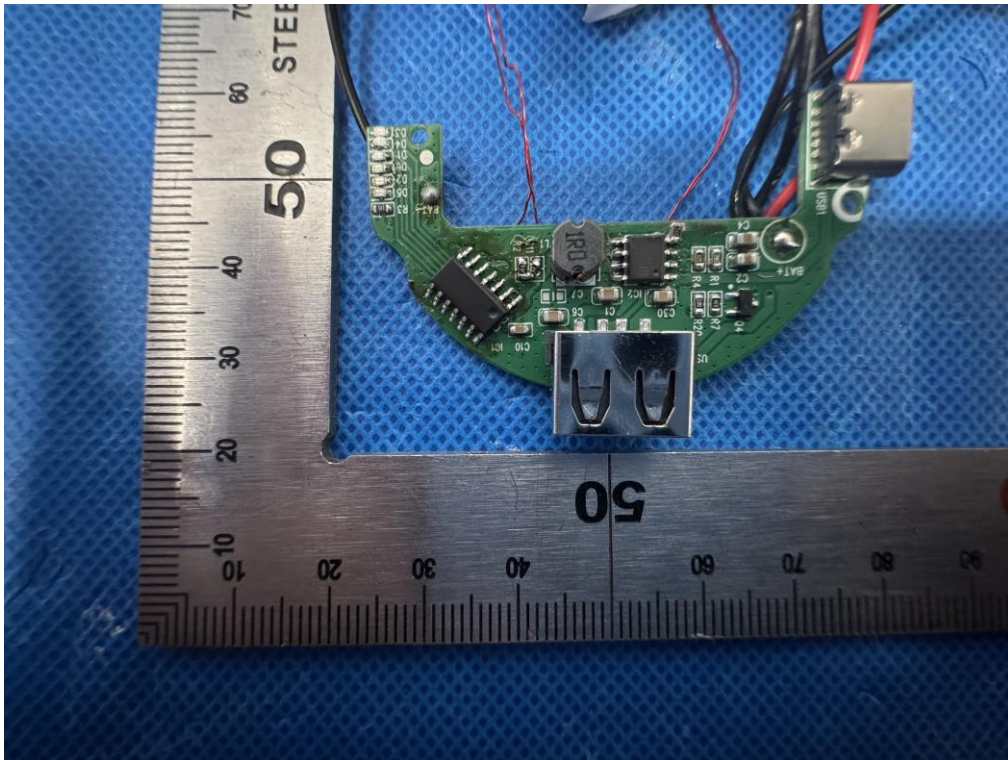

Internal view-2 of EUT



Battery view of EUT

Any report having not been signed by authorized approver, or having been altered without authorization, or having not been stamped by the "Dedicated Testing/Inspection Stamp" is deemed to be invalid. Copying or excerpting portion of, or altering the content of the report is not permitted without the written authorization of AGC. The test results presented in the report apply only to the tested sample. Any objections to report issued by AGC should be submitted to AGC within 15days after the issuance of the test report. Further enquiry of validity or verification of the test report should be addressed to AGC by agc01@agccert.com.

Conditions of Issuance of Test Reports

1. All samples and goods are accepted by the Attestation of Global Compliance (Shenzhen) Co., Ltd (the "Company") solely for testing and reporting in accordance with the following terms and conditions. The company provides its services on the basis that such terms and conditions constitute express agreement between the company and any person, firm or company requesting its services (the "Clients").
2. Any report issued by Company as a result of this application for testing services (the "Report") shall be issued in confidence to the Clients and the Report will be strictly treated as such by the Company. It may not be reproduced either in its entirety or in part and it may not be used for advertising or other unauthorized purposes without the written consent of the Company. The Clients to whom the Report is issued may, however, show or send it, or a certified copy thereof prepared by the Company to its customer, supplier or other persons directly concerned. The Company will not, without the consent of the Clients, enter into any discussion or correspondence with any third party concerning the contents of the Report, unless required by the relevant governmental authorities, laws or court orders.
3. The Company shall not be called or be liable to be called to give evidence or testimony on the Report in a court of law without its prior written consent, unless required by the relevant governmental authorities, laws or court orders.
4. In the event of the improper use of the report as determined by the Company, the Company reserves the right to withdraw it, and to adopt any other additional remedies which may be appropriate.
5. Samples submitted for testing are accepted on the understanding that the Report issued cannot form the basis of, or be the instrument for, any legal action against the Company.
6. The Company will not be liable for or accept responsibility for any loss or damage however arising from the use of information contained in any of its Reports or in any communication whatsoever about its said tests or investigations.
7. Clients wishing to use the Report in court proceedings or arbitration shall inform the Company to that effect prior to submitting the sample for testing.
8. The Company is not responsible for recalling the electronic version of the original report when any revision is made to them. The Client assumes the responsibility to providing the revised version to any interested party who uses them.
9. Subject to the variable length of retention time for test data and report stored hereinto as otherwise specifically required by individual accreditation authorities, the Company will only keep the supporting test data and information of the test report for a period of six years. The data and information will be disposed of after the aforementioned retention period has elapsed. Under no circumstances shall we provide any data and information which has been disposed of after retention period. Under no circumstances shall we be liable for damage of any kind, including (but not limited to) compensatory damages, lost profits, lost data, or any form of special, incidental, indirect, consequential or punitive damages of any kind, whether based on breach of contract of warranty, tort (including negligence), product liability or otherwise, even if we are informed in advance of the possibility of such damages.

----End of Report----

Any report having not been signed by authorized approver, or having been altered without authorization, or having not been stamped by the "Dedicated Testing/Inspection Stamp" is deemed to be invalid. Copying or excerpting portion of, or altering the content of the report is not permitted without the written authorization of AGC. The test results presented in the report apply only to the tested sample. Any objections to report issued by AGC should be submitted to AGC within 15days after the issuance of the test report. Further enquiry of validity or verification of the test report should be addressed to AGC by agc01@agccert.com.

EMC Test Report

Report No.: AGC05443251125EE02

PRODUCT DESIGNATION : Handwarmer power bank
BRAND NAME : N/A
MODEL NAME : M02777
APPLICANT : MID OCEAN BRANDS B.V.
DATE OF ISSUE : Nov. 21, 2025
STANDARD(S) : EN 55032:2015+A11:2020+A1:2020
EN 55035:2017+A11:2020
EN IEC 61000-3-2:2019+A1:2021+A2:2024
EN 61000-3-3:2013+A1:2019+A2:2021
REPORT VERSION : V1.0



Attestation of Global Compliance (Shenzhen) Co., Ltd

Any report having not been signed by authorized approver, or having been altered without authorization, or having not been stamped by the "Dedicated Testing/Inspection Stamp" is deemed to be invalid. Copying or excerpting portion of, or altering the content of the report is not permitted without the written authorization of AGC. The test results presented in the report apply only to the tested sample. Any objections to report issued by AGC should be submitted to AGC within 15days after the issuance of the test report. Further enquiry of validity or verification of the test report should be addressed to AGC by agc01@agccert.com.

Attestation of Global Compliance(Shenzhen)Co., Ltd
Attestation of Global Compliance(Shenzhen)Std & Tech Co., Ltd
Tel: +86-755 2523 4088 E-mail: agc@agccert.com Web: <http://www.agccert.com/>



REPORT REVISE RECORD

Report Version	Revise Time	Issued Date	Valid Version	Notes
V1.0	/	Nov. 21, 2025	Valid	Initial release

Any report having not been signed by authorized approver, or having been altered without authorization, or having not been stamped by the "Dedicated Testing/Inspection Stamp" is deemed to be invalid. Copying or excerpting portion of, or altering the content of the report is not permitted without the written authorization of AGC. The test results presented in the report apply only to the tested sample. Any objections to report issued by AGC should be submitted to AGC within 15days after the issuance of the test report. Further enquiry of validity or verification of the test report should be addressed to AGC by agc01@agccert.com.

Attestation of Global Compliance(Shenzhen)Co., Ltd
Attestation of Global Compliance(Shenzhen)Std & Tech Co., Ltd
Tel: +86-755 2523 4088 E-mail: agc@agccert.com Web: <http://www.agccert.com/>

Table of contents

1. General information 6

2. Description of Test Configuration 7

 2.1. Technical Description of Product 7

 2.2. Description of Support Equipment 8

 2.3. Description of Test Modes..... 8

3. Summary of Measurement Results and Uncertainty 9

 3.1. Test Specifications 9

 3.2. Description of Measurement Results..... 9

 3.3. Description of Measurement Uncertainty 11

4. Test Facility 12

5. Measurement of Conducted Emissions from the AC Mains Power Ports 13

 5.1. Requirements..... 13

 5.2. Block Diagram of Test Setup..... 13

 5.3. Equipment Details 14

 5.4. Configuration of the EUT and method of measurement..... 14

 5.5. Test Summary 15

6. Measurement of Radiated Emissions at Frequencies up to 1 GHz 17

 6.1. Requirements..... 17

 6.2. Block Diagram of Test Setup..... 17

 6.3. Equipment Details 18

 6.4. Configuration of the EUT and method of measurement..... 18

 6.5. Test Summary 19

7. Measurement of Harmonic Current Emissions..... 21

 7.1. Requirements..... 21

 7.2. Block Diagram of Test Setup..... 22

 7.3. Equipment Details 22

 7.4. Configuration of the EUT and method of measurement..... 22

 7.5. Test Summary 23

8. Measurement of Voltage Fluctuations and Flicker 24

 8.1. Requirements..... 24

 8.2. Block Diagram of Test Setup..... 24

 8.3. Equipment Details 24

 8.4. Configuration of the EUT and method of measurement..... 25

Any report having not been signed by authorized approver, or having been altered without authorization, or having not been stamped by the “Dedicated Testing/Inspection Stamp” is deemed to be invalid. Copying or excerpting portion of, or altering the content of the report is not permitted without the written authorization of AGC. The test results presented in the report apply only to the tested sample. Any objections to report issued by AGC should be submitted to AGC within 15days after the issuance of the test report. Further enquiry of validity or verification of the test report should be addressed to AGC by agc01@agccert.com.

8.5. Test Summary	25
9. Measurement of Electrostatic discharge.....	26
9.1. Requirements.....	26
9.2. Block Diagram of Test Setup.....	26
9.3. Equipment Details	27
9.4. Configuration of the EUT and method of measurement.....	27
9.5. Test Summary	28
10. Measurement of Radio-Frequency Electromagnetic Field	29
10.1. Requirements	29
10.2. Block Diagram of Test Setup	30
10.3. Equipment Details	31
10.4. Configuration of the EUT and method of measurement	31
10.5. Test Summary.....	32
11. Measurement of Radio-frequency common mode	33
11.1. Requirements	33
11.2. Block Diagram of Test Setup.....	33
11.3. Equipment Details	34
11.4. Configuration of the EUT and method of measurement	34
11.5. Test Summary.....	35
12. Measurement of Fast Transients	36
12.1. Requirements	36
12.2. Block Diagram of Test Setup.....	36
12.3. Equipment Details	37
12.4. Configuration of the EUT and method of measurement	37
12.5. Test Summary.....	38
13. Measurement of Surges	39
13.1. Requirements	39
13.2. Block Diagram of Test Setup.....	40
13.3. Equipment Details	40
13.4. Configuration of the EUT and method of measurement	41
13.5. Test Summary.....	41
14. Measurement of Voltage dips and interruptions	42
14.1. Requirements	42
14.2. Block Diagram of Test Setup.....	42
14.3. Equipment Details	43

Any report having not been signed by authorized approver, or having been altered without authorization, or having not been stamped by the “Dedicated Testing/Inspection Stamp” is deemed to be invalid. Copying or excerpting portion of, or altering the content of the report is not permitted without the written authorization of AGC. The test results presented in the report apply only to the tested sample. Any objections to report issued by AGC should be submitted to AGC within 15days after the issuance of the test report. Further enquiry of validity or verification of the test report should be addressed to AGC by agc01@agccert.com.

14.4. Configuration of the EUT and method of measurement 43

14.5. Test Summary..... 44

15. Photographs of Test Setup 45

16. Photographs of EUT 49

Any report having not been signed by authorized approver, or having been altered without authorization, or having not been stamped by the “Dedicated Testing/Inspection Stamp” is deemed to be invalid. Copying or excerpting portion of, or altering the content of the report is not permitted without the written authorization of AGC. The test results presented in the report apply only to the tested sample. Any objections to report issued by AGC should be submitted to AGC within 15days after the issuance of the test report. Further enquiry of validity or verification of the test report should be addressed to AGC by agc01@agccert.com.

1. General information

Applicant	MID OCEAN BRANDS B.V.
Address	Unit 711-716, 7/F., Tower A, 83 King Lam Street, Cheung Sha Wan, Kowloon, Hong Kong.
Manufacturer	MID OCEAN BRANDS B.V.
Address	Unit 711-716, 7/F., Tower A, 83 King Lam Street, Cheung Sha Wan, Kowloon, Hong Kong.
Factory	MID OCEAN BRANDS B.V.
Address	Unit 711-716, 7/F., Tower A, 83 King Lam Street, Cheung Sha Wan, Kowloon, Hong Kong.
Product Designation	Handwarmer power bank
Brand Name	N/A
Test Model	MO2777
Series Model(s)	N/A
Difference Description	N/A
Deviation from Standard	No any deviation from the test method
Date of receipt of test item	Nov. 13, 2025
Date of Test	Nov. 13, 2025 to Nov. 21, 2025
Test Result	Pass
Test Report Form No	AGCER-EMC-GEN-V1
Note: The test results of this report relate only to the tested sample identified in this report.	

Prepared By 

 Cici Li
 (Project Engineer) Nov. 21, 2025

Reviewed By 

 Jack Gui
 (Reviewer) Nov. 21, 2025

Approved By 

 Angela Li
 (Authorized Officer) Nov. 21, 2025

Any report having not been signed by authorized approver, or having been altered without authorization, or having not been stamped by the "Dedicated Testing/Inspection Stamp" is deemed to be invalid. Copying or excerpting portion of, or altering the content of the report is not permitted without the written authorization of AGC. The test results presented in the report apply only to the tested sample. Any objections to report issued by AGC should be submitted to AGC within 15days after the issuance of the test report. Further enquiry of validity or verification of the test report should be addressed to AGC by agc01@agccert.com.

2. Description of Test Configuration

2.1. Technical Description of Product

Categorization of Equipment	Class B equipment
Test arrangements of EUT	Table-top
Hardware Version	N/A
Software Version	N/A
Highest Internal Frequency	Less than 108MHz
EUT Input Rating	Type-C: DC 5V 1.5A
EUT Output Rating	USB-A: DC 5V 1A
Battery Information	DC 3.7V 5000mAh

Connection Diagram of Host System

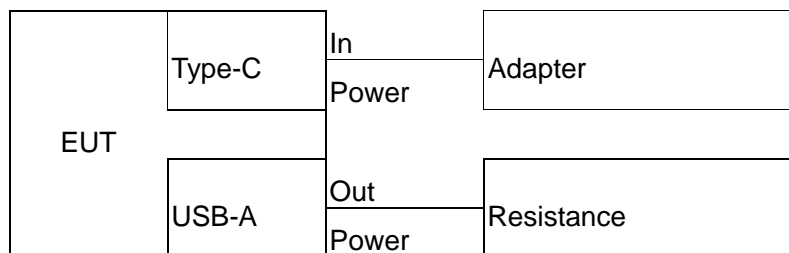

I/O Port Information (Applicable Not Applicable)

Port Type	Input/Output	Number	Cable Description
Type-C	In	1	0.5m unshielded
USB-A	Out	1	--

Any report having not been signed by authorized approver, or having been altered without authorization, or having not been stamped by the "Dedicated Testing/Inspection Stamp" is deemed to be invalid. Copying or excerpting portion of, or altering the content of the report is not permitted without the written authorization of AGC. The test results presented in the report apply only to the tested sample. Any objections to report issued by AGC should be submitted to AGC within 15days after the issuance of the test report. Further enquiry of validity or verification of the test report should be addressed to AGC by agc01@agccert.com.

2.2. Description of Support Equipment

Device Type	Manufacturer	Model Name	Serial No.	Data Cable	Power Cable
Cement Resistance	--	--	--	--	--
Digital Multi meter	FLUKE	15B+	--	--	--
Adapter	Apple	A2452	--	--	1.0m unshielded

2.3. Description of Test Modes

No.	Test Mode Description
1	Charging mode
2	USB-A Output: 5V=1A

Note: All modes have been tested for EMI and the worst mode is finally reflected.

Any report having not been signed by authorized approver, or having been altered without authorization, or having not been stamped by the "Dedicated Testing/Inspection Stamp" is deemed to be invalid. Copying or excerpting portion of, or altering the content of the report is not permitted without the written authorization of AGC. The test results presented in the report apply only to the tested sample. Any objections to report issued by AGC should be submitted to AGC within 15days after the issuance of the test report. Further enquiry of validity or verification of the test report should be addressed to AGC by agc01@agccert.com.

3. Summary of Measurement Results and Uncertainty

3.1. Test Specifications

EN 55032:2015+A11:2020+A1:2020	Electromagnetic compatibility of multimedia equipment - Emission requirements
EN 55035:2017+A11:2020	Electromagnetic compatibility of multimedia equipment - Immunity requirements
EN IEC 61000-3-2:2019+A1:2021+A2:2024	Electromagnetic compatibility (EMC) - Part 3-2: Limits - Limits for harmonic current emissions (equipment input current 16 A per phase)
EN 61000-3-3:2013+A1:2019+A2:2021	Electromagnetic compatibility (EMC) Part 3-3: Limits - Limitation of voltage changes, voltage fluctuations and flicker in public low-voltage supply systems, for equipment with rated current ≤ 16 A per phase and not subject to conditional connection

3.2. Description of Measurement Results

Test items	Test Standard(s)	Verdict
Conducted emissions from the AC mains power ports	EN 55032	Pass
Radiated emissions at frequencies up to 1 GHz	EN 55032	Pass
Harmonic current emissions	EN IEC 61000-3-2	Pass
Voltage fluctuations and flicker	EN 61000-3-3	Pass
Electrostatic discharge	IEC 61000-4-2 ^a	Pass
Radio-frequency electromagnetic field	IEC 61000-4-3 ^a	Pass
Fast transients	IEC 61000-4-4 ^a	Pass
Surges	IEC 61000-4-5 ^a	Pass
Radio-frequency common mode (Injected currents)	IEC 61000-4-6 ^a	Pass
Voltage dips and interruptions	IEC 61000-4-11 ^a	Pass

Note:

a. The applicable versions of the basic standards are defined in the standard which listed in the test specification.

Performance table

Performance Criteria for Immunity	
Performance criterion A	The equipment shall continue to operate as intended without operator intervention. No degradation of performance, loss of function or change of operating state is allowed below a performance level specified by the manufacturer when the equipment is used as intended. The performance level may be replaced by a permissible loss of performance. If the minimum performance level or the permissible performance loss is not specified by the manufacturer, then either of these may be derived from the product description and documentation, and by what the user may reasonably expect from the equipment if used as intended.
Performance criterion B	During the application of the disturbance, degradation of performance is allowed. However, no unintended change of actual operating state or stored data is allowed to persist after the test. After the test, the equipment shall continue to operate as intended without operator intervention; no degradation of performance or loss of function is allowed, below a performance level specified by the manufacturer, when the equipment is used as intended. The performance level may be replaced by a permissible loss of performance. If the minimum performance level (or the permissible performance loss), or recovery time, is not specified by the manufacturer, then either of these may be derived from the product description and documentation, and by what the user may reasonably expect from the equipment if used as intended.
Performance criterion C	Loss of function is allowed, provided the function is self-recoverable, or can be restored by the operation of the controls by the user in accordance with the manufacturer's instructions. A reboot or re-start operation is allowed. Information stored in non-volatile memory, or protected by a battery backup, shall not be lost.

Any report having not been signed by authorized approver, or having been altered without authorization, or having not been stamped by the "Dedicated Testing/Inspection Stamp" is deemed to be invalid. Copying or excerpting portion of, or altering the content of the report is not permitted without the written authorization of AGC. The test results presented in the report apply only to the tested sample. Any objections to report issued by AGC should be submitted to AGC within 15days after the issuance of the test report. Further enquiry of validity or verification of the test report should be addressed to AGC by agc01@agccert.com.

3.3. Description of Measurement Uncertainty

The reported uncertainty of measurement $y \pm U$, where expanded uncertainty U is based on a standard uncertainty multiplied by a coverage factor of $k=2$, providing a level of confidence of approximately 95%.

Item	Measurement Uncertainty
Conducted emissions from the AC mains power ports	$U_c = \pm 2.9$ dB
Radiated emissions at frequencies up to 1 GHz	$U_c = \pm 3.9$ dB

Any report having not been signed by authorized approver, or having been altered without authorization, or having not been stamped by the "Dedicated Testing/Inspection Stamp" is deemed to be invalid. Copying or excerpting portion of, or altering the content of the report is not permitted without the written authorization of AGC. The test results presented in the report apply only to the tested sample. Any objections to report issued by AGC should be submitted to AGC within 15days after the issuance of the test report. Further enquiry of validity or verification of the test report should be addressed to AGC by agc01@agccert.com.

4. Test Facility

Laboratory name: Attestation of Global Compliance (Shenzhen) Co., Ltd.

Laboratory Address: 1-2/F, Building 19, Junfeng Industrial Park, Chongqing Road, Heping Community, Fuhai Street, Bao'an District, Shenzhen, Guangdong, China

The test facility is recognized, certified, or accredited by the following organizations:

CNAS-Lab Code: L5488

Attestation of Global Compliance (Shenzhen) Co., Ltd. is accredited in accordance with the recognized International Standard ISO/IEC 17025 General Requirements for the Competence of Testing and Calibration Laboratories (CNAS-CL01 Accreditation Criteria for Testing and Calibration Laboratories).

A2LA-Lab Cert. No.: 5054.02

Attestation of Global Compliance (Shenzhen) Co., Ltd. is accredited in accordance with the recognized International Standard ISO/IEC 17025:2017 General requirements for the competence of testing and calibration laboratories. This laboratory also meets the requirements of any additional program requirements in the Electrical field.

FCC-Registration No.: 975832

Attestation of Global Compliance (Shenzhen) Co., Ltd. EMC Laboratory has been registered and fully described in a report filed with the FCC (Federal Communications Commission). The acceptance letter from the FCC is maintained in our files with Registration 975832.

IC-Registration No.: 24842

CAB identifier: CN0063

Attestation of Global Compliance (Shenzhen) Co., Ltd. EMC Laboratory has been registered and fully described in a report filed with the Certification and Engineering Bureau of Industry Canada. The acceptance letter from the IC is maintained in our files with Registration 24842.

VCCI Membership No.: 4112

Attestation of Global Compliance (Shenzhen) Co., Ltd. EMC Laboratory has been registered in accordance with VCCI Council Rules.

VCCI Registration No. C-20098 for conducted emissions at AC main power ports

VCCI Registration No. T-20102 for conducted emissions at telecommunication ports

VCCI Registration No. R-20136 for radiated emissions below 1GHz

VCCI Registration No. G-20132 for radiated emissions above 1GHz

Any report having not been signed by authorized approver, or having been altered without authorization, or having not been stamped by the "Dedicated Testing/Inspection Stamp" is deemed to be invalid. Copying or excerpting portion of, or altering the content of the report is not permitted without the written authorization of AGC. The test results presented in the report apply only to the tested sample. Any objections to report issued by AGC should be submitted to AGC within 15days after the issuance of the test report. Further enquiry of validity or verification of the test report should be addressed to AGC by agc01@agccert.com.

5. Measurement of Conducted Emissions from the AC Mains Power Ports

5.1. Requirements

Requirements for conducted emissions, low voltage AC mains port

Network device	Detector type/ bandwidth	Frequency Range (MHz)	Limits dB(μ V)	Measurement specifications
AMN	Quasi-peak/ 9kHz	0.15 to 0.5	66 to 56	Instrumentation: CISPR 16-1-1, Clauses 4, 5 and 7 Networks: CISPR 16-1-2, Clause 4 Method: CISPR 16-2-1, Clause 7 Set-up: CISPR 16-2-1, Clause 7
		0.5 to 5	56	
		5 to 30	60	
	Average/ 9kHz	0.15 to 0.5	56 to 46	
		0.5 to 5	46	
		5 to 30	50	

Note:

1. The lower limit shall apply at the transition frequency.
2. The limit decreases linearly with the logarithm of the frequency in the range 0.15 to 0.5MHz.

5.2. Block Diagram of Test Setup

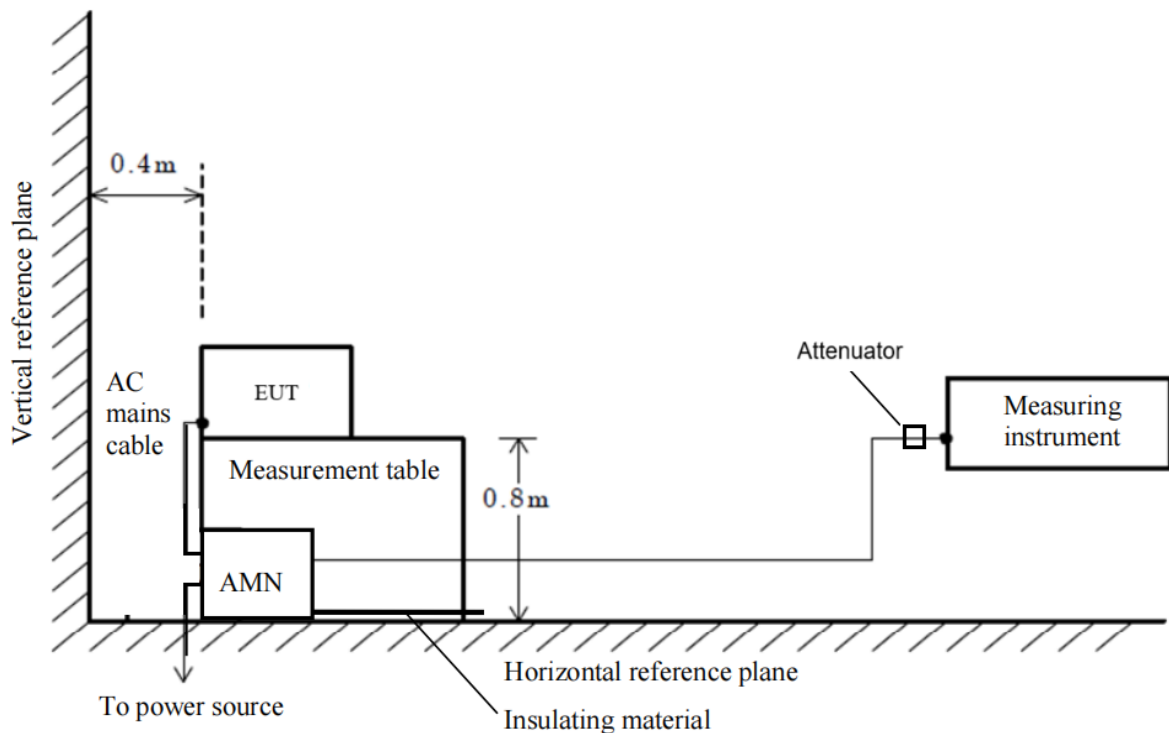

Any report having not been signed by authorized approver, or having been altered without authorization, or having not been stamped by the "Dedicated Testing/Inspection Stamp" is deemed to be invalid. Copying or excerpting portion of, or altering the content of the report is not permitted without the written authorization of AGC. The test results presented in the report apply only to the tested sample. Any objections to report issued by AGC should be submitted to AGC within 15days after the issuance of the test report. Further enquiry of validity or verification of the test report should be addressed to AGC by agc01@agccert.com.

5.3. Equipment Details

Measuring Instruments

Instruments No.	Instruments	Manufacturer	Model	S/N	Cal. Date	Cal. Due
AGC-EM-A171	Attenuator	Mini-Circuits	UNAT-10A+	N/A	2024-02-01	2026-01-31
AGC-EM-E023	Artificial Mains Network	R&S	ESH2-Z5	100086	2025-05-08	2026-05-07
AGC-EM-E116	Test Receiver	R&S	ESCI	100034	2025-05-08	2026-05-07

Measuring Software

Software No.	Software Name	Manufacturer	Details
AGC-EM-S001	ES-K1	R&S	For EMC Measurement, Version 1.71

5.4. Configuration of the EUT and method of measurement

- a. The EUT was set up as per the test configuration to simulate typical actual usage per the user's manual. When the EUT is a tabletop system, the EUT was placed on the top surface of a measurement table, 0.8 m high from the horizontal reference plane, and was positioned at a distance of 0.4 m away from the vertical reference plane. When the EUT is a floor-standing equipment, it is placed on the ground plane which has a 10 cm non-conductive covering to insulate the EUT from the ground plane.
- b. Support equipment, if needed, was placed as per CISPR 16-2-1.
- c. All I/O cables were positioned to simulate typical actual usage as per CISPR 16-2-1.
- d. The EMI receiver measured the emission levels emanating from the EUT into the AC Mains through an Artificial Mains Network (AMN) and an attenuator used on the front end of the EMI receiver. Testing included measurements on all live and neutral lines.
- e. The more description of the tests, the test methods, and the test set-ups are given in the applicable test standard.
- f. Record at least six highest emissions relative to the limits at each frequency of interest unless the emission is 10 dB or greater below the limit.
- g. A conducted emission is calculated by the following equation:
 - Measurement Level (dB μ V) = Receiver reading (dB μ V) + Tansd (dB)
 - Transd(dB)= AMN Factor(dB)+Cable Loss(dB)+Attenuation(dB)
 - Margin= Limit-Level

Any report having not been signed by authorized approver, or having been altered without authorization, or having not been stamped by the "Dedicated Testing/Inspection Stamp" is deemed to be invalid. Copying or excerpting portion of, or altering the content of the report is not permitted without the written authorization of AGC. The test results presented in the report apply only to the tested sample. Any objections to report issued by AGC should be submitted to AGC within 15days after the issuance of the test report. Further enquiry of validity or verification of the test report should be addressed to AGC by agc01@agccert.com.

5.5. Test Summary

Test Engineer	Kobe Chen	Temperature	21.5°C
Test Date	2025-11-18	Air Pressure	985 Mbar
Worst Mode	Mode 1	Relative Humidity	52.2%
Verdict	Pass		

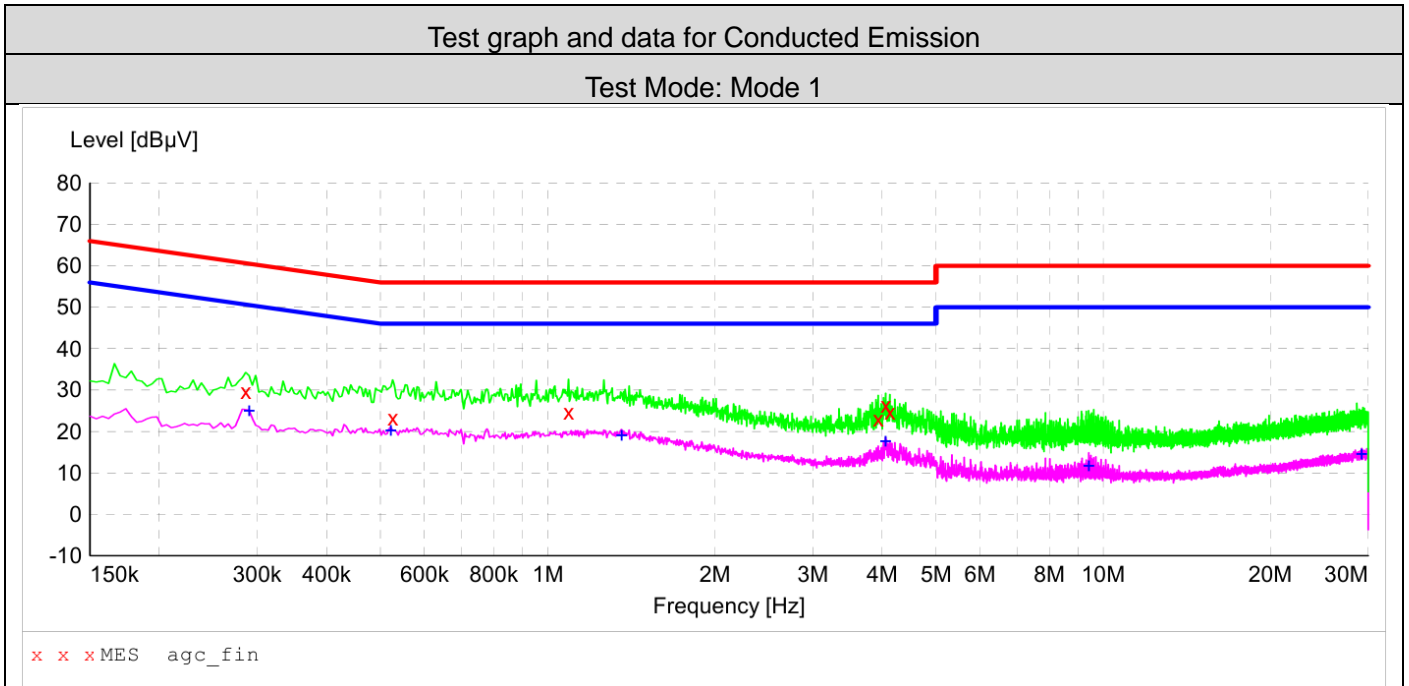

Frequency [MHz]	Level [dBµV]	Factor [dB]	Limit [dBµV]	Margin [dB]	Detector	Line
0.286000	29.7	10.3	60.6	30.9	QP	L1
0.526000	23.2	10.3	56.0	32.8	QP	L1
1.090000	24.6	10.4	56.0	31.4	QP	L1
3.934000	23.1	10.7	56.0	32.9	QP	L1
4.058000	26.3	10.7	56.0	29.7	QP	L1
4.130000	24.7	10.7	56.0	31.3	QP	L1
0.290000	24.8	10.3	50.5	25.7	AV	L1
0.522000	20.2	10.3	46.0	25.8	AV	L1
1.358000	19.1	10.4	46.0	26.9	AV	L1
4.054000	17.5	10.7	46.0	28.5	AV	L1
9.422000	11.7	12.1	50.0	38.3	AV	L1
29.186000	14.4	17.9	50.0	35.6	AV	L1

Any report having not been signed by authorized approver, or having been altered without authorization, or having not been stamped by the "Dedicated Testing/Inspection Stamp" is deemed to be invalid. Copying or excerpting portion of, or altering the content of the report is not permitted without the written authorization of AGC. The test results presented in the report apply only to the tested sample. Any objections to report issued by AGC should be submitted to AGC within 15days after the issuance of the test report. Further enquiry of validity or verification of the test report should be addressed to AGC by agc01@agccert.com.

Test graph and data for Conducted Emission

Test Mode: Mode 1

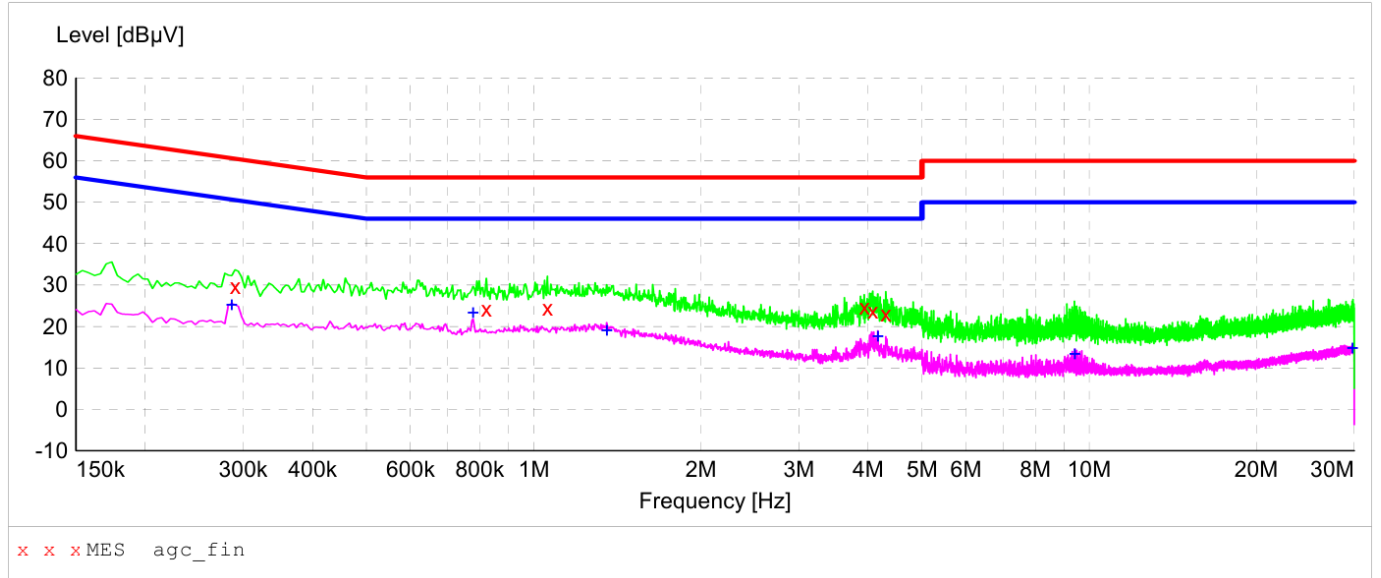

Frequency [MHz]	Level [dBµV]	Factor [dB]	Limit [dBµV]	Margin [dB]	Detector	Line
0.290000	29.6	10.3	60.5	30.9	QP	N
0.822000	24.1	10.4	56.0	31.9	QP	N
1.058000	24.5	10.4	56.0	31.5	QP	N
3.938000	24.7	10.7	56.0	31.3	QP	N
4.078000	23.8	10.7	56.0	32.2	QP	N
4.306000	23.1	10.7	56.0	32.9	QP	N
0.286000	25.1	10.3	50.6	25.5	AV	N
0.778000	23.3	10.3	46.0	22.7	AV	N
1.354000	19.1	10.4	46.0	26.9	AV	N
4.166000	17.5	10.7	46.0	28.5	AV	N
9.418000	13.3	12.1	50.0	36.7	AV	N
29.786000	14.7	18.1	50.0	35.3	AV	N

Any report having not been signed by authorized approver, or having been altered without authorization, or having not been stamped by the "Dedicated Testing/Inspection Stamp" is deemed to be invalid. Copying or excerpting portion of, or altering the content of the report is not permitted without the written authorization of AGC. The test results presented in the report apply only to the tested sample. Any objections to report issued by AGC should be submitted to AGC within 15days after the issuance of the test report. Further enquiry of validity or verification of the test report should be addressed to AGC by agc01@agccert.com.

6. Measurement of Radiated Emissions at Frequencies up to 1 GHz

6.1. Requirements

Requirements for radiated emissions at frequencies up to 1 GHz at 3m distance

Test facility	Detector type/ bandwidth	Frequency Range (MHz)	Limits dB(μ V/m)	Measurement specifications
SAC	Quasi-peak/ 120kHz	30 to 230	40	Instrumentation: CISPR 16-1-1, Clauses 4, 5 Antennas: CISPR 16-1-4, Clause 4.5 Test Site: CISPR 16-1-4, Clause 6 Method: CISPR 16-2-3, Clause 7.6
		230 to 1000	47	

Note:

- The lower limit shall apply at the transition frequency.

6.2. Block Diagram of Test Setup

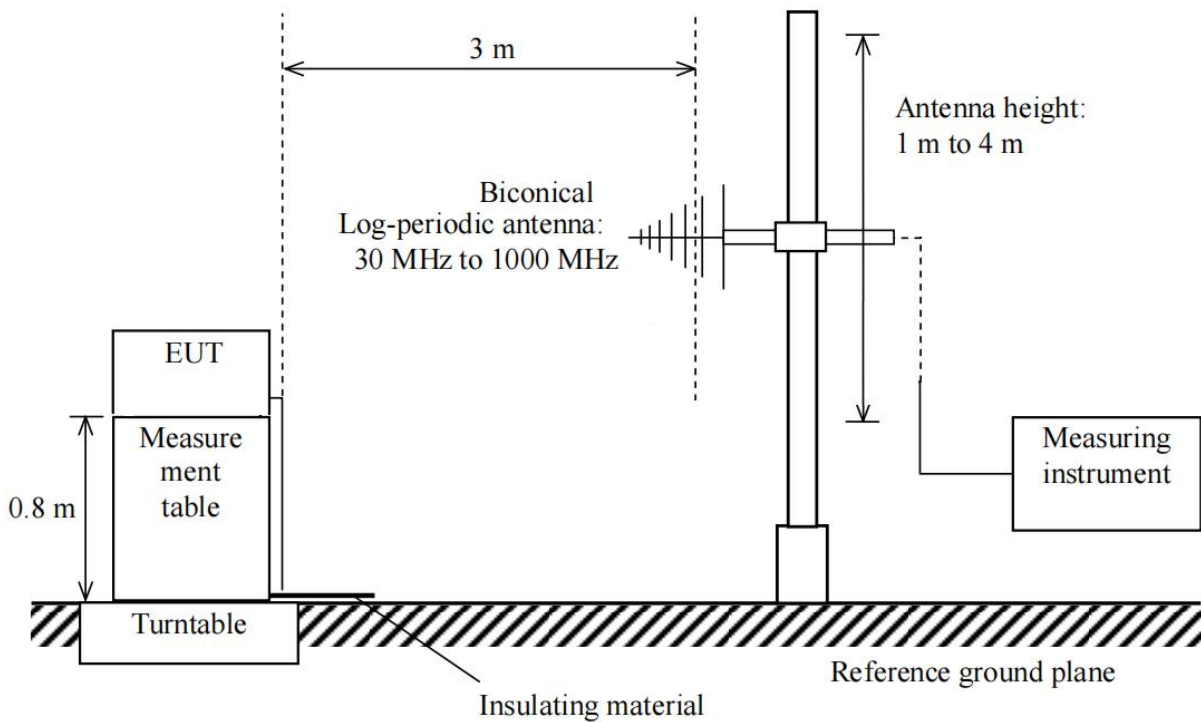

Any report having not been signed by authorized approver, or having been altered without authorization, or having not been stamped by the "Dedicated Testing/Inspection Stamp" is deemed to be invalid. Copying or excerpting portion of, or altering the content of the report is not permitted without the written authorization of AGC. The test results presented in the report apply only to the tested sample. Any objections to report issued by AGC should be submitted to AGC within 15 days after the issuance of the test report. Further enquiry of validity or verification of the test report should be addressed to AGC by agc01@agccert.com.

6.3. Equipment Details

Measuring Instruments

Instruments No.	Instruments	Manufacturer	Model	S/N	Cal. Date	Cal. Due
AGC-EM-E046	Test Receiver	R&S	ESCI	100096	2025-01-14	2026-01-13
AGC-EM-E001	Antenna	SCHWARZBECK	VULB9168	D69250	2025-03-14	2027-03-13
AGC-EM-A138	Attenuator	East sheep	LM-XX-6-5W	N/A	2025-05-16	2027-05-15

Measuring Software

Software No.	Software Name	Manufacturer	Details
AGC-EM-S004	TS+[JS32-RE]	Tonscend	For EMC Measurement, Version 4.0.0.0

6.4. Configuration of the EUT and method of measurement

- a. The EUT was set up as per the test configuration to simulate typical actual usage per the user's manual. When the EUT is a tabletop system, the EUT was placed on the top surface of a measurement table, 0.8 m high from the horizontal reference plane. When the EUT is a floor-standing equipment, it is placed on the ground plane which has a 10 cm non-conductive covering to insulate the EUT from the ground plane.
- b. Support equipment, if needed, was placed as per CISPR 16-2-3.
- c. All I/O cables were positioned to simulate typical actual usage as per CISPR 16-2-3.
- d. The maximum receiving level of radiated emissions from the EUT was measured while the turntable was rotated from 0° to 360° and the antenna height was scanned between 1 m and 4 m. The cables were laid out to attain the maximum level of radiated emissions.
- e. The more description of the tests, the test methods, and the test set-ups are given in the applicable test standard.
- f. Record at least six highest emissions relative to the limits at each frequency of interest unless the emission is 10 dB or greater below the limit.
- g. A radiated emission is calculated by the following equation:
 - Measurement Level dB(μV/m) = Receiver reading dB(μV) + Factor(dB/m)
 - Factor(dB/m) = Antenna Factor(dB/m) + Cable Loss(dB)
 - Margin= Limit-Level

Any report having not been signed by authorized approver, or having been altered without authorization, or having not been stamped by the "Dedicated Testing/Inspection Stamp" is deemed to be invalid. Copying or excerpting portion of, or altering the content of the report is not permitted without the written authorization of AGC. The test results presented in the report apply only to the tested sample. Any objections to report issued by AGC should be submitted to AGC within 15days after the issuance of the test report. Further enquiry of validity or verification of the test report should be addressed to AGC by agc01@agccert.com.

6.5. Test Summary

Test Engineer	Tom Chen	Temperature	22.4°C
Test Date	2025-11-17	Air Pressure	985 Mbar
Worst Mode	Mode 2	Relative Humidity	54.8 %
Verdict	Pass		

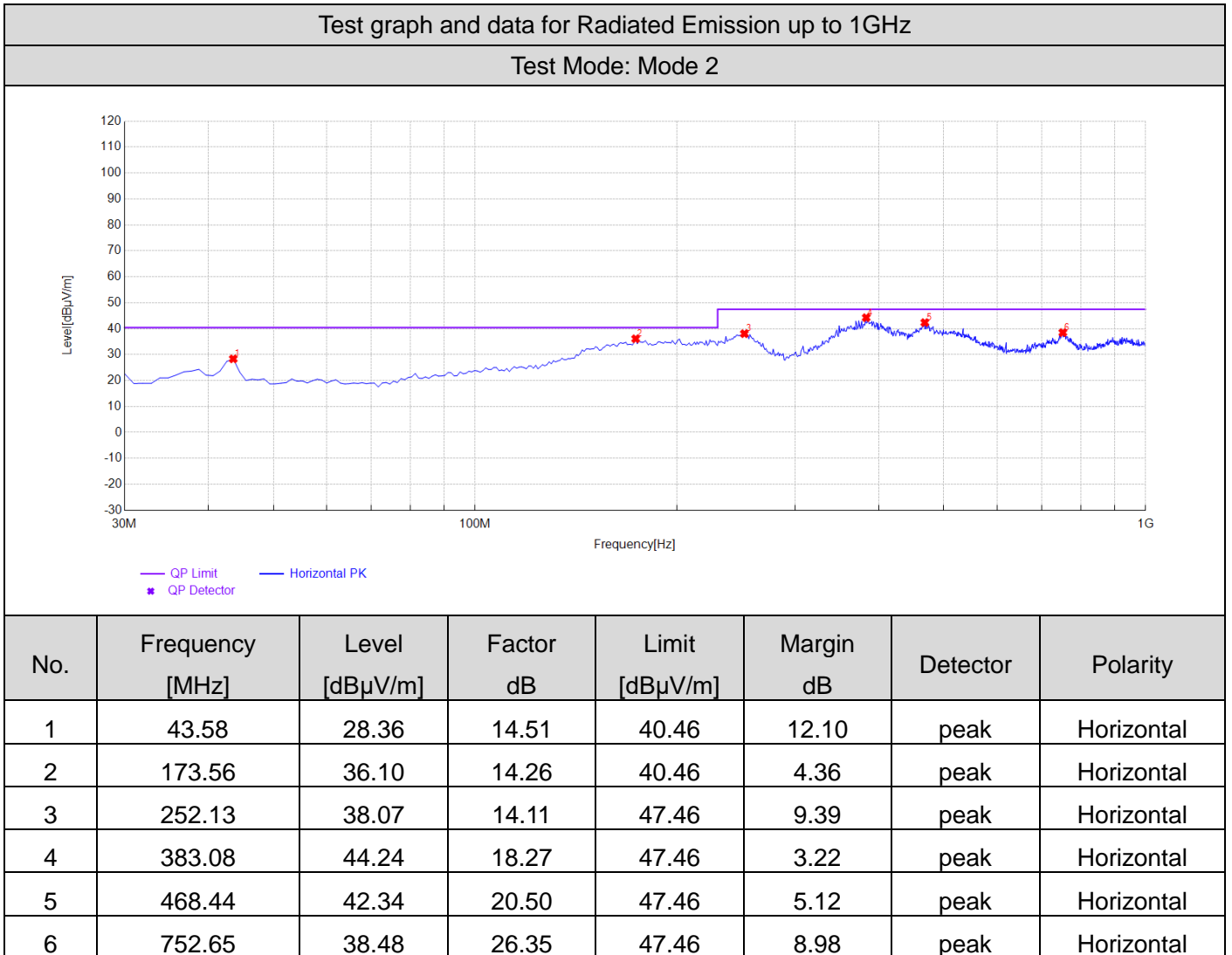

Any report having not been signed by authorized approver, or having been altered without authorization, or having not been stamped by the “Dedicated Testing/Inspection Stamp” is deemed to be invalid. Copying or excerpting portion of, or altering the content of the report is not permitted without the written authorization of AGC. The test results presented in the report apply only to the tested sample. Any objections to report issued by AGC should be submitted to AGC within 15days after the issuance of the test report. Further enquiry of validity or verification of the test report should be addressed to AGC by agc01@agccert.com.

Test graph and data for Radiated Emission up to 1GHz

Test Mode: Mode 2

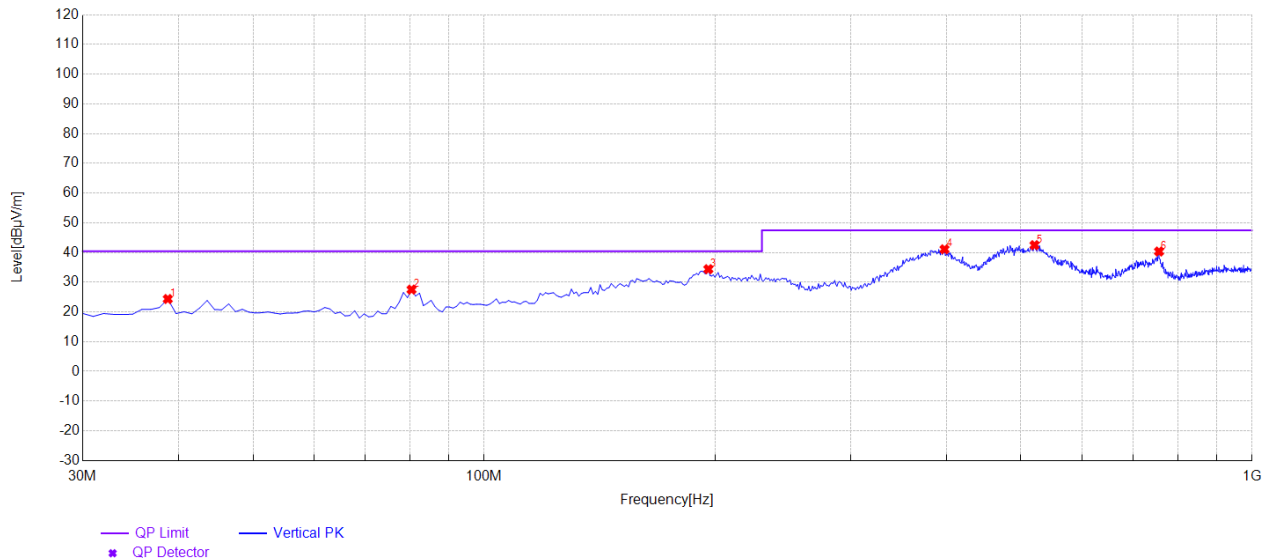

No.	Frequency [MHz]	Level [dBµV/m]	Factor dB	Limit [dBµV/m]	Margin dB	Detector	Polarity
1	38.73	24.35	14.47	40.46	16.11	peak	Vertical
2	80.44	27.51	10.90	40.46	12.95	peak	Vertical
3	195.87	34.38	12.37	40.46	6.08	peak	Vertical
4	397.63	41.08	18.63	47.46	6.38	peak	Vertical
5	520.82	42.46	21.46	47.46	5.00	peak	Vertical
6	756.53	40.34	26.45	47.46	7.12	peak	Vertical

Any report having not been signed by authorized approver, or having been altered without authorization, or having not been stamped by the "Dedicated Testing/Inspection Stamp" is deemed to be invalid. Copying or excerpting portion of, or altering the content of the report is not permitted without the written authorization of AGC. The test results presented in the report apply only to the tested sample. Any objections to report issued by AGC should be submitted to AGC within 15days after the issuance of the test report. Further enquiry of validity or verification of the test report should be addressed to AGC by agc01@agccert.com.

7. Measurement of Harmonic Current Emissions

7.1. Requirements

Applicable test standard(s): EN IEC 61000-3-2:2019+A1:2021+A2:2024

Limits of Harmonic Current Emissions

Harmonic order <i>h</i>	Limits				
	Class A	Class B	Class C ^a	Class D	
	Maximum permissible harmonic current (A)		Maximum permissible harmonic current expressed as a percentage of the input current at the fundamental frequency (%)	Maximum permissible harmonic current per watt (mA/W)	Maximum permissible harmonic current (A)
3	2.30	3.45	27 ^b	3.4	2.30
5	1.14	1.71	10	1.9	1.14
7	0.77	1.155	7	1.0	0.77
9	0.40	0.6	5	0.5	0.40
11	0.33	0.495	3	0.35	0.33
13	0.21	0.315	3	3.85/13	0.21
15 ≤ <i>h</i> ≤ 39 (odd harmonics only)	2.25/ <i>h</i>	3.375/ <i>h</i>	3	3.85/ <i>h</i>	2.25/ <i>h</i>
2	1.08	1.62	2	Not applicable	Not applicable
4	0.43	0.645	Not applicable		
6	0.30	0.45			
8 ≤ <i>h</i> ≤ 40 (even harmonics only)	1.84/ <i>h</i>	2.76/ <i>h</i>			

Note:
(a) For some Class C products, other emission limits apply.
(b) The limit is determined based on the assumption of modern lighting technologies having power factors of 0.90 or higher.

The application of limits had been as defined in the applicable test standard.

7.2. Block Diagram of Test Setup

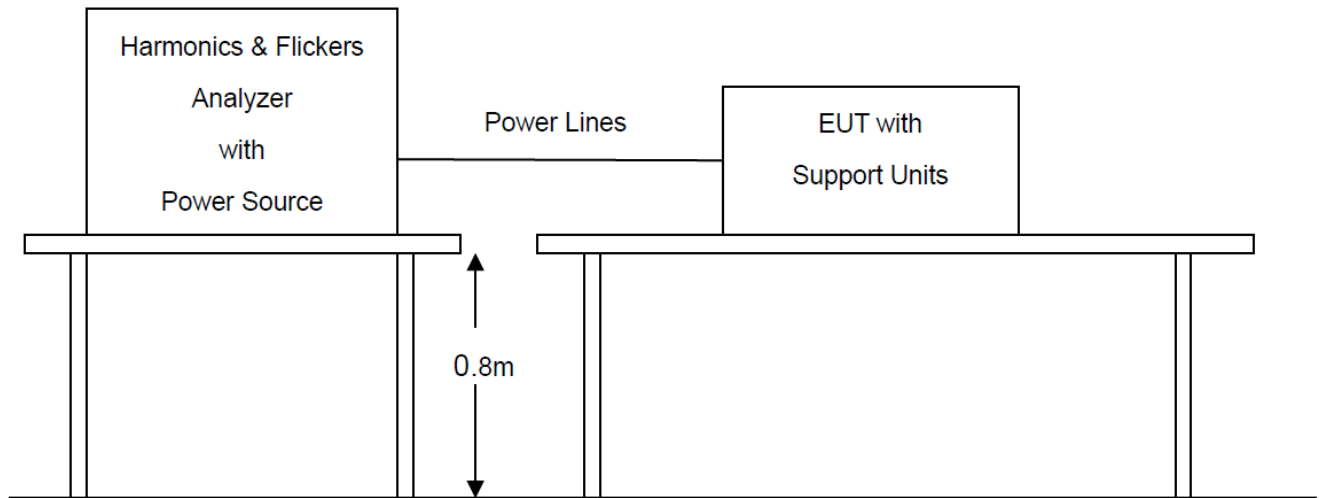

7.3. Equipment Details

Measuring Instruments

Instruments No.	Instruments	Manufacturer	Model	S/N	Cal. Date	Cal. Due
AGC-EM-E033	Signal Conditioning Unit	Schaffner	CCN1000-1	72431	2025-05-16	2026-05-15
AGC-EM-E015	AC Source	Schaffner	NSG 1007	56825	2025-05-16	2026-05-15

Measuring Software

Software No.	Software Name	Manufacturer	Details
AGC-EM-S005	CTS 4	AMETEK	For Harmonics And Flickers Measurement, Version 4.29.0

7.4. Configuration of the EUT and method of measurement

- a. The test shall be conducted according to the general requirements given in the applicable test standard. The test duration had been as defined in the applicable test standard.
- b. The measurement of harmonic currents shall be performed as follows:
 - for each harmonic order, measure the 1.5 s smoothed RMS harmonic current in each discrete Fourier transform (DFT) time window;
 - calculate the arithmetic average of the measured values from the DFT time windows, over the entire observation period.
- c. The value of the active input power to be used for the calculation of limits shall be determined as follows:
 - measure the 1.5 s smoothed active input power in each DFT time window;
 - determine the maximum of the measured values of active power from the DFT time windows over the entire duration of the test.

Any report having not been signed by authorized approver, or having been altered without authorization, or having not been stamped by the "Dedicated Testing/Inspection Stamp" is deemed to be invalid. Copying or excerpting portion of, or altering the content of the report is not permitted without the written authorization of AGC. The test results presented in the report apply only to the tested sample. Any objections to report issued by AGC should be submitted to AGC within 15days after the issuance of the test report. Further enquiry of validity or verification of the test report should be addressed to AGC by agc01@agccert.com.

- d. The harmonic currents and the active input power shall be measured under the same test conditions but need not be measured simultaneously.

7.5. Test Summary

Equipment with a rated power less than or equal to 75W is deemed to fulfil all relevant requirements of this standard without testing.

Any report having not been signed by authorized approver, or having been altered without authorization, or having not been stamped by the “Dedicated Testing/Inspection Stamp” is deemed to be invalid. Copying or excerpting portion of, or altering the content of the report is not permitted without the written authorization of AGC. The test results presented in the report apply only to the tested sample. Any objections to report issued by AGC should be submitted to AGC within 15days after the issuance of the test report. Further enquiry of validity or verification of the test report should be addressed to AGC by agc01@agccert.com.

Attestation of Global Compliance(Shenzhen)Co., Ltd
Attestation of Global Compliance(Shenzhen)Std & Tech Co., Ltd
Tel: +86-755 2523 4088 E-mail: agc@agccert.com Web: <http://www.agccert.com/>

8. Measurement of Voltage Fluctuations and Flicker

8.1. Requirements

Applicable test standard(s): EN 61000-3-3:2013+A1:2019+A2:2021

Limits of Voltage Fluctuations and Flicker

Parameters	Definitions	Limits
T_{max}	the accumulated time value of $d(t)$ with a deviation exceeding 3.3 % during a single voltage change at the EUT terminals	≤ 500 ms
d_c	the maximum relative steady-state voltage change	$\leq 3.3\%$
d_{max}	the maximum relative voltage change	<input checked="" type="checkbox"/> $\leq 4\%$ <input type="checkbox"/> $\leq 6\%$ <input type="checkbox"/> $\leq 7\%$
<input checked="" type="checkbox"/> P_{st}	short-term flicker severity	≤ 1.0
<input type="checkbox"/> P_{lt}	long-term flicker severity	≤ 0.65

8.2. Block Diagram of Test Setup

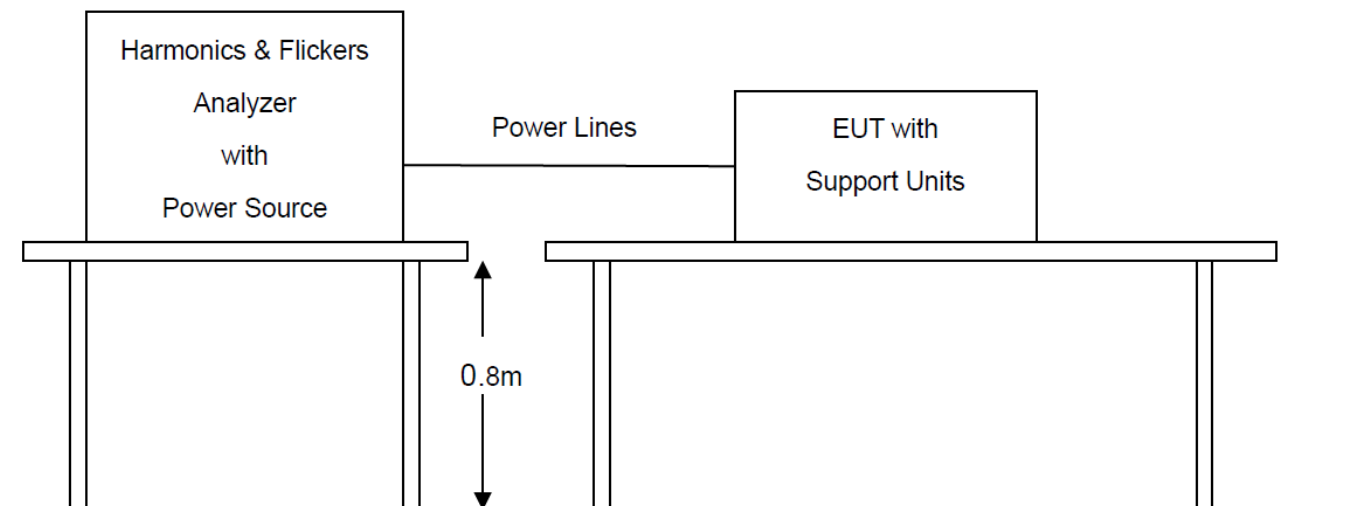

8.3. Equipment Details

Measuring Instruments

Instruments No.	Instruments	Manufacturer	Model	S/N	Cal. Date	Cal. Due
AGC-EM-E033	Signal Conditioning Unit	Schaffner	CCN1000-1	72431	2025-05-16	2026-05-15
AGC-EM-E015	AC Source	Schaffner	NSG 1007	56825	2025-05-16	2026-05-15

Measuring Software

Software No.	Software Name	Manufacturer	Details
AGC-EM-S005	CTS 4	AMETEK	For Harmonics And Flickers Measurement, Version 4.29.0

Any report having not been signed by authorized approver, or having been altered without authorization, or having not been stamped by the "Dedicated Testing/Inspection Stamp" is deemed to be invalid. Copying or excerpting portion of, or altering the content of the report is not permitted without the written authorization of AGC. The test results presented in the report apply only to the tested sample. Any objections to report issued by AGC should be submitted to AGC within 15days after the issuance of the test report. Further enquiry of validity or verification of the test report should be addressed to AGC by agc01@agccert.com.

8.4. Configuration of the EUT and method of measurement

- a. The test shall be conducted according to the general requirements given in the applicable test standard. The test duration and test condition had been as defined in the applicable test standard.
- b. All types of voltage fluctuations would be assessed by direct measurement using a flicker meter which complies with the specification given in IEC 61000-4-15:2010.

8.5. Test Summary

Test Engineer	Kobe Chen	Temperature	21.5°C
Test Date	2025-11-18	Air Pressure	985 Mbar
Worst Mode	Mode 1	Relative Humidity	52.2%
Verdict	Pass		

Parameters	Measurement Value	Limits
T_{max}	0	≤ 500 ms
d_c	0.00	$\leq 3.3\%$
d_{max}	0.00	$\leq 4\%$
P_{st}	0.253	≤ 1.0

Any report having not been signed by authorized approver, or having been altered without authorization, or having not been stamped by the "Dedicated Testing/Inspection Stamp" is deemed to be invalid. Copying or excerpting portion of, or altering the content of the report is not permitted without the written authorization of AGC. The test results presented in the report apply only to the tested sample. Any objections to report issued by AGC should be submitted to AGC within 15days after the issuance of the test report. Further enquiry of validity or verification of the test report should be addressed to AGC by agc01@agccert.com.

9. Measurement of Electrostatic discharge

9.1. Requirements

Port	Enclosure
Basic Standard	IEC 61000-4-2
Test Level	±8.0 kV (Air Discharge) ±4.0 kV (Contact Discharge) ±4.0 kV (Indirect Discharge)
Required Performance Criterion	B
Time Between Each Discharge:	1 second
Number of Discharge for Each Applied Voltage	10

9.2. Block Diagram of Test Setup

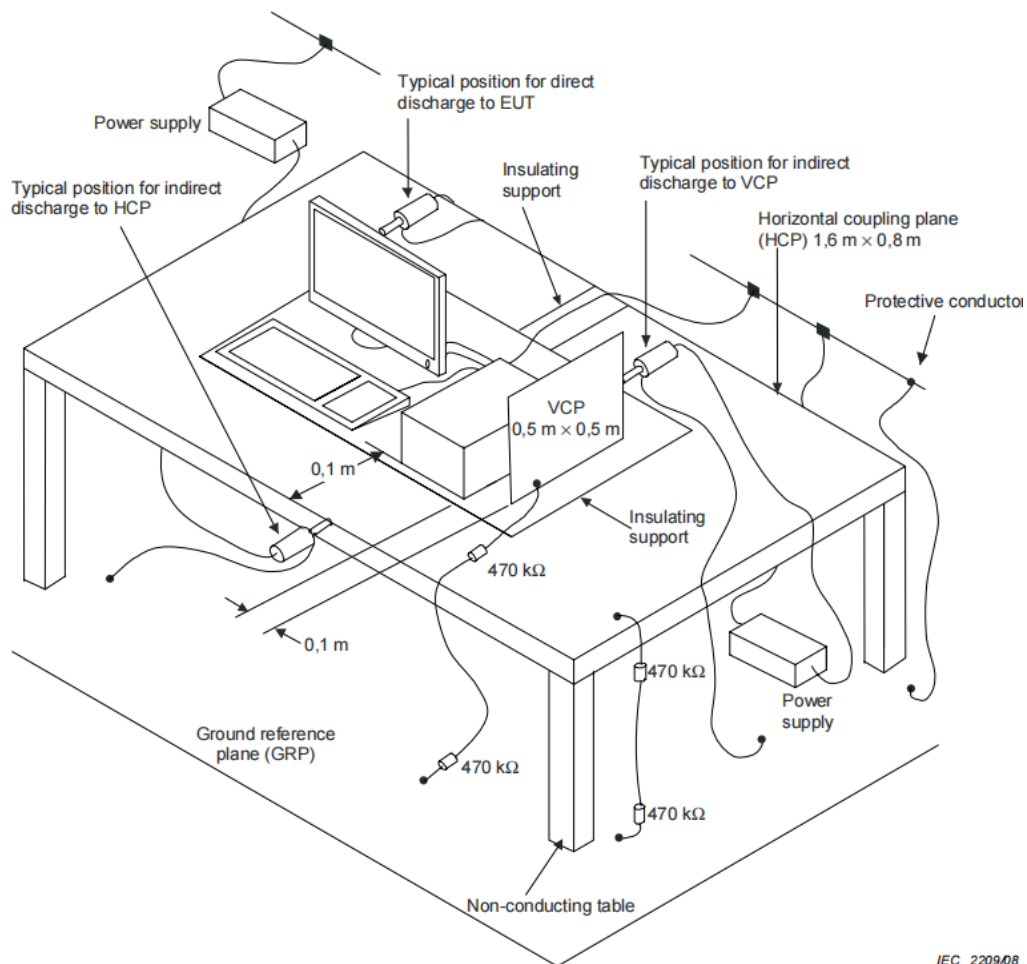

Any report having not been signed by authorized approver, or having been altered without authorization, or having not been stamped by the “Dedicated Testing/Inspection Stamp” is deemed to be invalid. Copying or excerpting portion of, or altering the content of the report is not permitted without the written authorization of AGC. The test results presented in the report apply only to the tested sample. Any objections to report issued by AGC should be submitted to AGC within 15 days after the issuance of the test report. Further enquiry of validity or verification of the test report should be addressed to AGC by agc01@agccert.com.

9.3. Equipment Details

Measuring Instruments

Instruments No.	Instruments	Manufacturer	Model	S/N	Cal. Date	Cal. Due
AGC-EM-E013	ESD Simulator	Schaffner	NSG 438	782	2025-11-03	2026-11-02

Measuring Software

Software No.	Software Name	Manufacturer	Details
--	--	--	--

9.4. Configuration of the EUT and method of measurement

- a. Electrostatic discharges were applied only to those points and surfaces of the EUT that are accessible to users during normal operation.
- b. The test was performed with at least ten single discharges on the pre-selected points in the most sensitive polarity.
- c. The time interval between two successive single discharges was at least 1 second.
- d. The ESD generator was held perpendicularly to the surface to which the discharge was applied and the return cable was at least 0.2 meters from the EUT.
- e. Contact discharges were applied to the non-insulating coating, with the pointed tip of the generator penetrating the coating and contacting the conducting substrate.
- f. Air discharges were applied with the round discharge tip of the discharge electrode approaching the EUT as fast as possible (without causing mechanical damage) to touch the EUT. After each discharge, the ESD generator was removed from the EUT and re-triggered for a new single discharge. The test was repeated until all discharges were completed.
- g. At least ten single discharges (in the most sensitive polarity) were applied to the Horizontal Coupling Plane at points on each side of the EUT. The ESD generator was positioned vertically at a distance of 0.1 meters from the EUT with the discharge electrode touching the HCP.
- h. At least ten single discharges (in the most sensitive polarity) were applied to the center of one vertical edge of the Vertical Coupling Plane in sufficiently different positions that the four faces of the EUT were completely illuminated. The VCP (dimensions 0.5m×0.5m) was placed vertically to and 0.1 meters from the EUT.
- i. The test results shall be classified in terms of the loss of function or degradation of performance of the equipment under test, relative to a performance criterion defined in the report.

Any report having not been signed by authorized approver, or having been altered without authorization, or having not been stamped by the "Dedicated Testing/Inspection Stamp" is deemed to be invalid. Copying or excerpting portion of, or altering the content of the report is not permitted without the written authorization of AGC. The test results presented in the report apply only to the tested sample. Any objections to report issued by AGC should be submitted to AGC within 15days after the issuance of the test report. Further enquiry of validity or verification of the test report should be addressed to AGC by agc01@agccert.com.

9.5. Test Summary

Test Engineer	Jimu Lao	Temperature	18.2 °C
Test Date	2025-11-19	Air Pressure	985 Mbar
Test Mode(s)	Mode 1/2	Relative Humidity	48.2 %
Verdict	Pass		

Voltage	Coupling	Observation	Performance
±4kV	Contact Discharge	No degradation of performance	A
±2KV, ±4kV, ±8kV	Air Discharge	No degradation of performance	A
±4kV	Indirect Discharge HCP	No degradation of performance	A
±4kV	Indirect Discharge VCP	No degradation of performance	A

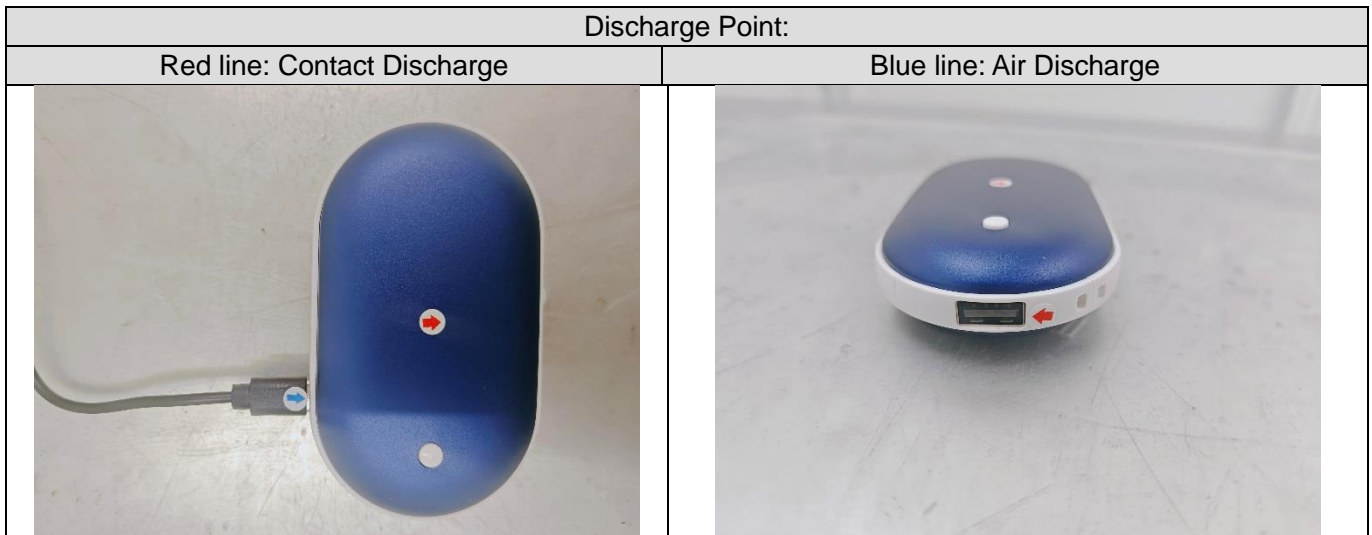

Any report having not been signed by authorized approver, or having been altered without authorization, or having not been stamped by the “Dedicated Testing/Inspection Stamp” is deemed to be invalid. Copying or excerpting portion of, or altering the content of the report is not permitted without the written authorization of AGC. The test results presented in the report apply only to the tested sample. Any objections to report issued by AGC should be submitted to AGC within 15days after the issuance of the test report. Further enquiry of validity or verification of the test report should be addressed to AGC by agc01@agccert.com.

10. Measurement of Radio-Frequency Electromagnetic Field

10.1. Requirements

Port	Enclosure
Basic Standard	IEC 61000-4-3
Test Level	Swept test: 3V/m with 80% AM. 1kHz Modulation at 80 to 1000MHz Spot test (Frequency (± 1 %)): 3V/m with 80% AM. 1kHz Modulation at 1800, 2600, 3500, 5000MHz
Required Performance Criterion	A
Antenna polarization	Vertical and Horizontal
Step size increment ^a	1%
Dwell time ^b	≤ 5 seconds
Test Distance	3m
EUT position facing antenna	Front side, back side, left side and right side

Notes:

- a. Recognizing that a 1% step size is preferred, the frequency range can be swept incrementally with a step size not exceeding 4% of the previous frequency with a test level of twice the value of the specified test level in order to reduce the testing time for equipment requiring testing in multiple configurations and/or long cycle times.
- b. The dwell time at each frequency shall not be less than the time necessary for the EUT to be exercised and to be able to respond. However, the dwell time shall not exceed 5 seconds at each of the frequencies during the scan. The time to exercise the EUT is not interpreted as a total time of a program or a cycle but related to the reaction time in case of failure of the EUT.

10.2. Block Diagram of Test Setup

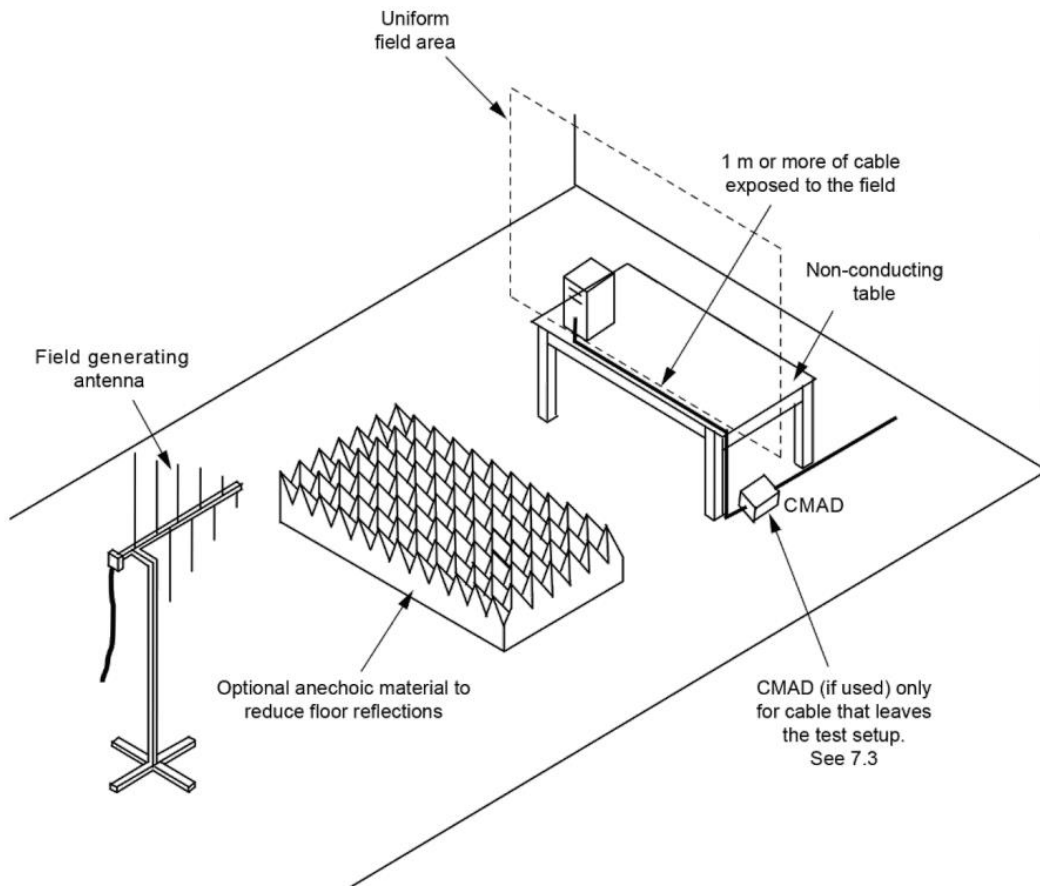

Any report having not been signed by authorized approver, or having been altered without authorization, or having not been stamped by the “Dedicated Testing/Inspection Stamp” is deemed to be invalid. Copying or excerpting portion of, or altering the content of the report is not permitted without the written authorization of AGC. The test results presented in the report apply only to the tested sample. Any objections to report issued by AGC should be submitted to AGC within 15days after the issuance of the test report. Further enquiry of validity or verification of the test report should be addressed to AGC by agc01@agccert.com.

10.3. Equipment Details

Measuring Instruments

Instruments No.	Instruments	Manufacturer	Model	S/N	Cal. Date	Cal. Due
AGC-EM-E005	Power Meter	R&S	NRVD	8323781027	2025-03-24	2027-03-23
AGC-EM-E016	Power Amplifier	KALMUS	7100LC	04-02/17-06-001	2025-07-18	2026-07-17
AGC-EM-E028	Wideband Antenna	ETS-LINDGREN	3142C	60447	N/A	N/A
AGC-EM-E029	Antenna	ETS	3117	34609	2025-03-27	2026-03-26
AGC-EM-E035	Power Probe	R&S	URV5-Z4	100124	2025-03-24	2027-03-23
AGC-EM-E040	Directional Coupler	Werlatone	C5571-10	99463	2024-02-01	2026-01-31
AGC-EM-E041	Directional Coupler	Werlatone	C6026-10	99482	2024-02-01	2026-01-31
AGC-EM-E080	Power Amplifier	Rflight	NTWPA-2560100	17063183	2025-07-18	2026-07-17
AGC-EM-E115	Signal Generator	AGILENT	N5182A	MY49060745	2025-03-07	2026-03-06
AGC-EM-E160	Power Amplifier	TESEQ	CBA3G-100	T43913	2025-05-21	2026-05-20

Measuring Software

Software No.	Software Name	Manufacturer	Details
AGC-EM-S006	TS+[JS35-RS]	Tonscend	For EMC Measurement, Version 2.0.1.8

10.4. Configuration of the EUT and method of measurement

- a. The Equipment Under Test (EUT) was positioned within the Uniform Field Area (UFA) on a supporting table, ensuring a 3-meter separation from the transmitting antenna. This setup aligns with the calibrated square area, guaranteeing field uniformity during testing. The supporting units were strategically located outside the UFA to avoid any potential interference. Nonetheless, the cables connected to the EUT were intentionally exposed to the precisely calibrated field within the UFA.
- b. Before testing, it will verify the proper operation of the test equipment/system. This verification will involve measuring the field strength at one point within the Uniform Field Area (UFA) at various frequencies.
- c. The test shall be performed according to the above requirements and block diagram which shall specify the test setup.
- d. The test results shall be classified in terms of the loss of function or degradation of performance of the equipment under test, relative to a performance criterion defined in the report.

Any report having not been signed by authorized approver, or having been altered without authorization, or having not been stamped by the "Dedicated Testing/Inspection Stamp" is deemed to be invalid. Copying or excerpting portion of, or altering the content of the report is not permitted without the written authorization of AGC. The test results presented in the report apply only to the tested sample. Any objections to report issued by AGC should be submitted to AGC within 15days after the issuance of the test report. Further enquiry of validity or verification of the test report should be addressed to AGC by agc01@agccert.com.

10.5. Test Summary

Test Engineer	Tom Chen	Temperature	22.4°C
Test Date	2025-11-17	Air Pressure	985 Mbar
Test Mode(s)	Mode 1/2	Relative Humidity	54.8 %
Verdict	Pass		

Swept test:

Frequency	Exposed Side	Field Strength (V/m)	Observation	Performance
80MHz to 6GHz	Front	3V/m (rms)	No degradation of performance	A
80MHz to 6GHz	Left	3V/m (rms)	No degradation of performance	A
80MHz to 6GHz	Rear	3V/m (rms)	No degradation of performance	A
80MHz to 6GHz	Right	3V/m (rms)	No degradation of performance	A

Spot test (Frequency (±1 %)):

Frequency	Exposed Side	Field Strength (V/m)	Observation	Performance
1800, 2600, 3500, 5000MHz	Front	3V/m (rms)	No degradation of performance	A
1800, 2600, 3500, 5000MHz	Left	3V/m (rms)	No degradation of performance	A
1800, 2600, 3500, 5000MHz	Rear	3V/m (rms)	No degradation of performance	A
1800, 2600, 3500, 5000MHz	Right	3V/m (rms)	No degradation of performance	A

Any report having not been signed by authorized approver, or having been altered without authorization, or having not been stamped by the “Dedicated Testing/Inspection Stamp” is deemed to be invalid. Copying or excerpting portion of, or altering the content of the report is not permitted without the written authorization of AGC. The test results presented in the report apply only to the tested sample. Any objections to report issued by AGC should be submitted to AGC within 15days after the issuance of the test report. Further enquiry of validity or verification of the test report should be addressed to AGC by agc01@agccert.com.

11. Measurement of Radio-frequency common mode

11.1. Requirements

Port	<input checked="" type="checkbox"/> AC mains power ports	<input type="checkbox"/> Analogue/digital data ports ^a	<input type="checkbox"/> DC network power ports ^a
Basic Standard	IEC 61000-4-6		
Required Performance Criterion	A		
Test Level	0.15 to 10 MHz, 3 V RMS (unmodulated), 80 % AM (1 kHz) 10 to 30 MHz, 3 to 1 V RMS (unmodulated), 80 % AM (1 kHz) 30 to 80 MHz, 1 V RMS (unmodulated), 80 % AM (1 kHz)		
Step size increment ^b	1%		
Dwell time ^c	≤5 seconds		

Notes:

- Applicable only to ports which, according to the manufacturer's specification, supports cable lengths greater than 3 m.
- Recognizing that a 1% step size is preferred, the frequency range can be swept incrementally with a step size not exceeding 4% of the previous frequency with a test level of twice the value of the specified test level in order to reduce the testing time for equipment requiring testing in multiple configurations and/or long cycle times.
- The dwell time at each frequency shall not be less than the time necessary for the EUT to be exercised and to be able to respond. However, the dwell time shall not exceed 5 seconds at each of the frequencies during the scan. The time to exercise the EUT is not interpreted as a total time of a program or a cycle but related to the reaction time in case of failure of the EUT.

11.2. Block Diagram of Test Setup

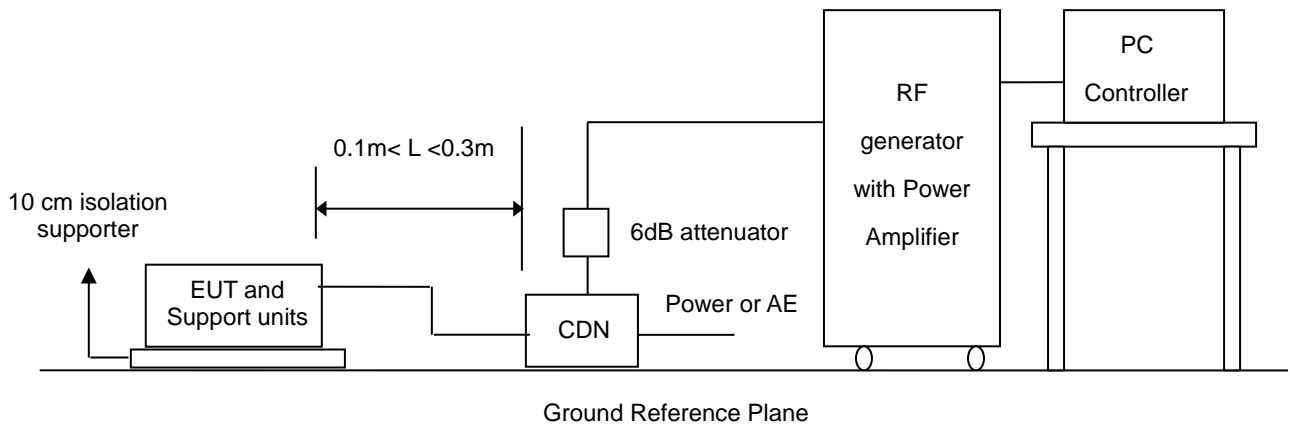

Any report having not been signed by authorized approver, or having been altered without authorization, or having not been stamped by the "Dedicated Testing/Inspection Stamp" is deemed to be invalid. Copying or excerpting portion of, or altering the content of the report is not permitted without the written authorization of AGC. The test results presented in the report apply only to the tested sample. Any objections to report issued by AGC should be submitted to AGC within 15days after the issuance of the test report. Further enquiry of validity or verification of the test report should be addressed to AGC by agc01@agccert.com.

11.3. Equipment Details

Measuring Instruments

Instruments No.	Instruments	Manufacturer	Model	S/N	Cal. Date	Cal. Due
AGC-EM-A048	Attenuator	ZHINAN	E-002	N/A	2024-07-24	2026-07-23
AGC-EM-E005	Power Meter	R&S	NRVD	8323781027	2025-03-24	2027-03-23
AGC-EM-E017	Power Amplifier	AR	75A250	18464	2025-07-18	2026-07-17
AGC-EM-E035	Power Probe	R&S	URV5-Z4	100124	2025-03-24	2027-03-23
AGC-EM-E040	Directional Coupler	Werlatone	C5571-10	99463	2024-02-01	2026-01-31
AGC-EM-E115	Signal Generator	Aglient	N5182A	MY49060745	2025-03-07	2026-03-06
AGC-EM-E161	CDN	3C TEST	CDN M2M3	ES064002624028	2025-09-05	2026-09-04

Measuring Software

Software No.	Software Name	Manufacturer	Details
AGC-EM-S007	TS+[JS35-CS]	Tonscend	For EMC measurement, version 2.0.1.7

11.4. Configuration of the EUT and method of measurement

- a. The Equipment Under Test (EUT) shall be tested within its intended operating and climatic conditions.
- b. The test generator and the coupling/decoupling network shall be placed directly on, and bonded to, the ground reference plane. The test shall be performed with the test generator connected to each of the coupling devices (CDN, EM clamp, current clamp) in turn. All other cables not under test shall either be disconnected (when functionally allowed) or provided with decoupling networks or unterminated CDNs only.
- c. The test shall be performed according to the above requirements and block diagram which shall specify the test setup.
- d. The test results shall be classified in terms of the loss of function or degradation of performance of the equipment under test, relative to a performance criterion defined in the report.

Any report having not been signed by authorized approver, or having been altered without authorization, or having not been stamped by the "Dedicated Testing/Inspection Stamp" is deemed to be invalid. Copying or excerpting portion of, or altering the content of the report is not permitted without the written authorization of AGC. The test results presented in the report apply only to the tested sample. Any objections to report issued by AGC should be submitted to AGC within 15days after the issuance of the test report. Further enquiry of validity or verification of the test report should be addressed to AGC by agc01@agccert.com.

11.5. Test Summary

Test Engineer	Jimu Lao	Temperature	18.2 °C
Test Date	2025-11-15	Air Pressure	985 Mbar
Test Mode(s)	Mode 1	Relative Humidity	48.2 %
Verdict	Pass		

Test port	Test Level	Coupling method	Observation	Performance
AC Mains Input	0.15 to 10 MHz: 3 V	CDN	No degradation of performance	A
	10 to 30 MHz: 3 to 1 V			
	30 to 80 MHz, 1 V			

Any report having not been signed by authorized approver, or having been altered without authorization, or having not been stamped by the “Dedicated Testing/Inspection Stamp” is deemed to be invalid. Copying or excerpting portion of, or altering the content of the report is not permitted without the written authorization of AGC. The test results presented in the report apply only to the tested sample. Any objections to report issued by AGC should be submitted to AGC within 15days after the issuance of the test report. Further enquiry of validity or verification of the test report should be addressed to AGC by agc01@agccert.com.

12. Measurement of Fast Transients

12.1. Requirements

Port	<input checked="" type="checkbox"/> AC mains power ports	<input type="checkbox"/> Analogue/digital data ports ^a	<input type="checkbox"/> DC network power ports ^a
Basic Standard	IEC 61000-4-4		
Required Performance Criterion	B		
Test Level	1 kV (peak)	0.5 kV (peak)	0.5 kV (peak)
Polarity	Positive/Negative		
Impulse Frequency	5kHz		
Impulse wave shape	5/50ns		
Burst Duration	15ms		
Burst Period	300ms		
Notes:			
a. Applicable only to ports which, according to the manufacturer's specification, supports cable lengths greater than 3 m.			

12.2. Block Diagram of Test Setup

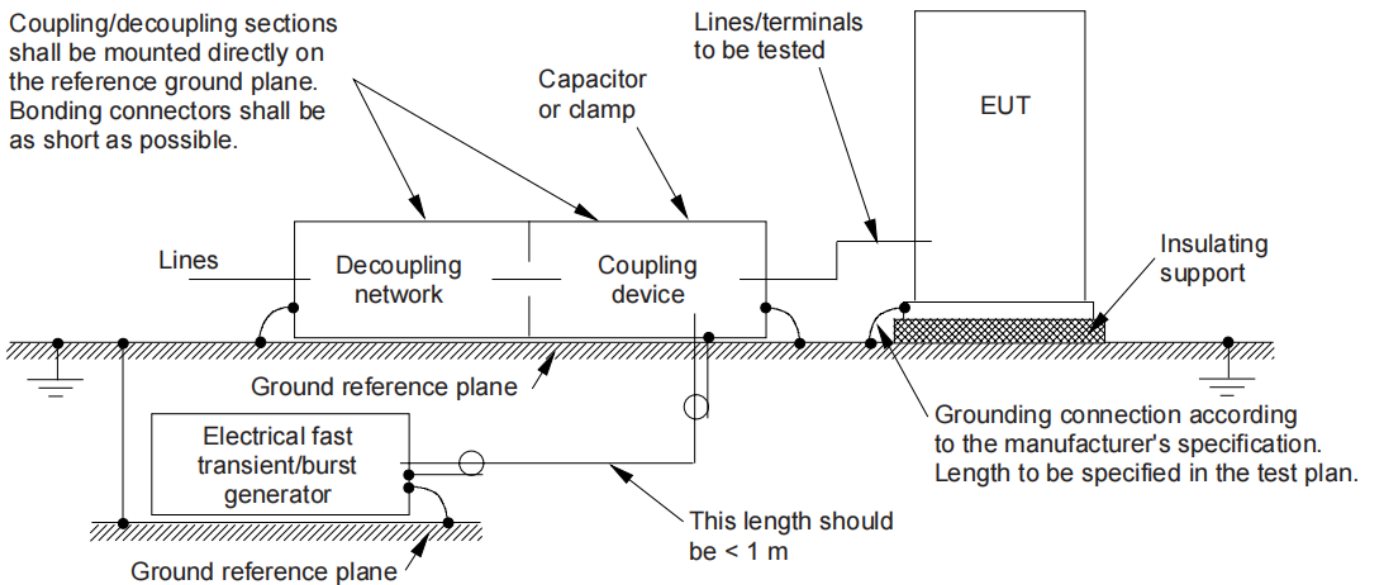

Any report having not been signed by authorized approver, or having been altered without authorization, or having not been stamped by the "Dedicated Testing/Inspection Stamp" is deemed to be invalid. Copying or excerpting portion of, or altering the content of the report is not permitted without the written authorization of AGC. The test results presented in the report apply only to the tested sample. Any objections to report issued by AGC should be submitted to AGC within 15days after the issuance of the test report. Further enquiry of validity or verification of the test report should be addressed to AGC by agc01@agccert.com.

12.3. Equipment Details

Measuring Instruments

Instruments No.	Instruments	Manufacturer	Model	S/N	Cal. Date	Cal. Due
AGC-EM-E008	EFT/Surge/DIPS Generator	Schaffner	Modula 6150	34437	2025-05-08	2026-05-07

Measuring Software

Software No.	Software Name	Manufacturer	Details
AGC-EM-S009	WinModula	Schaffner	For EFT/Surge/Dips Measurement, Version 2.31 c

12.4. Configuration of the EUT and method of measurement

- a. The Equipment Under Test (EUT), whether stationary floor-mounted or table top, and equipment designed to be mounted in other configurations, shall be placed on a ground reference plane and shall be insulated from it by an insulating support 0,1 m ± 0,01 m thick.
- b. The test generator and the coupling/decoupling network shall be placed directly on, and bonded to, the ground reference plane.
- c. The EUT shall be arranged and connected to satisfy its functional requirements, according to the equipment installation specifications. The minimum distance between the EUT and all other conductive structures (e.g. the walls of a shielded room), except the ground reference plane shall be more than 0,5 m. All cables to the EUT shall be placed on the insulation support 0,1 m above the ground reference plane. Cables not subject to electrical fast transients shall be routed as far as possible from the cable under test to minimize the coupling between the cables.
- d. The test voltages shall be coupled to all of the EUT ports including those between two units of equipment involved in the test, unless the length of the interconnecting cable makes it impossible to test.
- e. Either a direct coupling network or a capacitive clamp shall be used for the application of the test voltages.
- f. The test results shall be classified in terms of the loss of function or degradation of performance of the equipment under test, relative to a performance criterion defined in the report.

Any report having not been signed by authorized approver, or having been altered without authorization, or having not been stamped by the "Dedicated Testing/Inspection Stamp" is deemed to be invalid. Copying or excerpting portion of, or altering the content of the report is not permitted without the written authorization of AGC. The test results presented in the report apply only to the tested sample. Any objections to report issued by AGC should be submitted to AGC within 15days after the issuance of the test report. Further enquiry of validity or verification of the test report should be addressed to AGC by agc01@agccert.com.

12.5. Test Summary

Test Engineer	Jimu Lao	Temperature	18.2 °C
Test Date	2025-11-15	Air Pressure	985 Mbar
Test Mode(s)	Mode 1	Relative Humidity	48.2 %
Verdict	Pass		

Inject Line	Voltage(kV)	Inject Method	Observation	Performance
AC Lines	0.5, 1	Direct	No degradation of performance	A

Any report having not been signed by authorized approver, or having been altered without authorization, or having not been stamped by the “Dedicated Testing/Inspection Stamp” is deemed to be invalid. Copying or excerpting portion of, or altering the content of the report is not permitted without the written authorization of AGC. The test results presented in the report apply only to the tested sample. Any objections to report issued by AGC should be submitted to AGC within 15days after the issuance of the test report. Further enquiry of validity or verification of the test report should be addressed to AGC by agc01@agccert.com.

13. Measurement of Surges

13.1. Requirements

Port	<input checked="" type="checkbox"/> AC mains power ports ^a	<input type="checkbox"/> Analogue/digital data ports ^{b, c, d and e}		<input type="checkbox"/> DC network power ports ^f
		<input type="checkbox"/> Unshielded symmetrical	<input type="checkbox"/> Coaxial or shielded	
Basic Standard	IEC 61000-4-5			
Required Performance Criterion	B	C	B	B
Test Level	Line to line: 1 kV; Line to ground: 2 kV	primary protection is intended: 1 and 4 kV (line to ground); primary protection is not intended: 1 kV (line to ground)	shield to ground: 0.5 kV	Line to ground: 0.5 kV
Tr/Th	1.2/50 (8/20) μ s	10/700 (5/320) μ s	1.2/50 (8/20) μ s	1.2/50 (8/20) μ s
Number of impulses	Five positive and five negative impulses			
Time between successive impulses	1 min			

Notes:

- a. The number of pulses applied shall be as follows:
 - Five positive pulses line-to-neutral at 90° phase.
 - Five negative pulses line-to-neutral at 270° phase.
 The following additional pulses are required only if the EUT has an earth connection or if the EUT is earthed via any AE:
 - Five positive pulses line-to-earth at 90° phase.
 - Five negative pulses line-to-earth at 270° phase.
 - Five negative pulses neutral-to-earth at 90° phase.
 - Five positive pulses neutral-to-earth at 270° phase.
- b. Applicable only to ports which, according to the manufacturer’s specification, supports cable lengths greater than 3 m.
- c. Surges are applied with primary protection fitted. Where possible, use the actual primary protector intended to be used in the installation.
- d. Where the surge coupling network for the 10/700 (5/320) μ s waveform affects the functioning of high speed data ports, the test shall be carried out using a 1.2/50 (8/20) μ s waveform and appropriate coupling network.
- e. Surges are applicable to ports which satisfy all of the following conditions:
 - May connect directly to cables that leave the building structure.
 - Defined as an antenna port, a wired network port, or a broadcast receiver tuner port.
 Typical ports covered include xDSL, PSTN, CATV, antenna and similar. Excluded ports are LAN and similar.
- f. Applicable only to ports which, according to the manufacturer’s specification, may connect directly to outdoor cables.

Any report having not been signed by authorized approver, or having been altered without authorization, or having not been stamped by the “Dedicated Testing/Inspection Stamp” is deemed to be invalid. Copying or excerpting portion of, or altering the content of the report is not permitted without the written authorization of AGC. The test results presented in the report apply only to the tested sample. Any objections to report issued by AGC should be submitted to AGC within 15days after the issuance of the test report. Further enquiry of validity or verification of the test report should be addressed to AGC by agc01@agccert.com.

13.2. Block Diagram of Test Setup

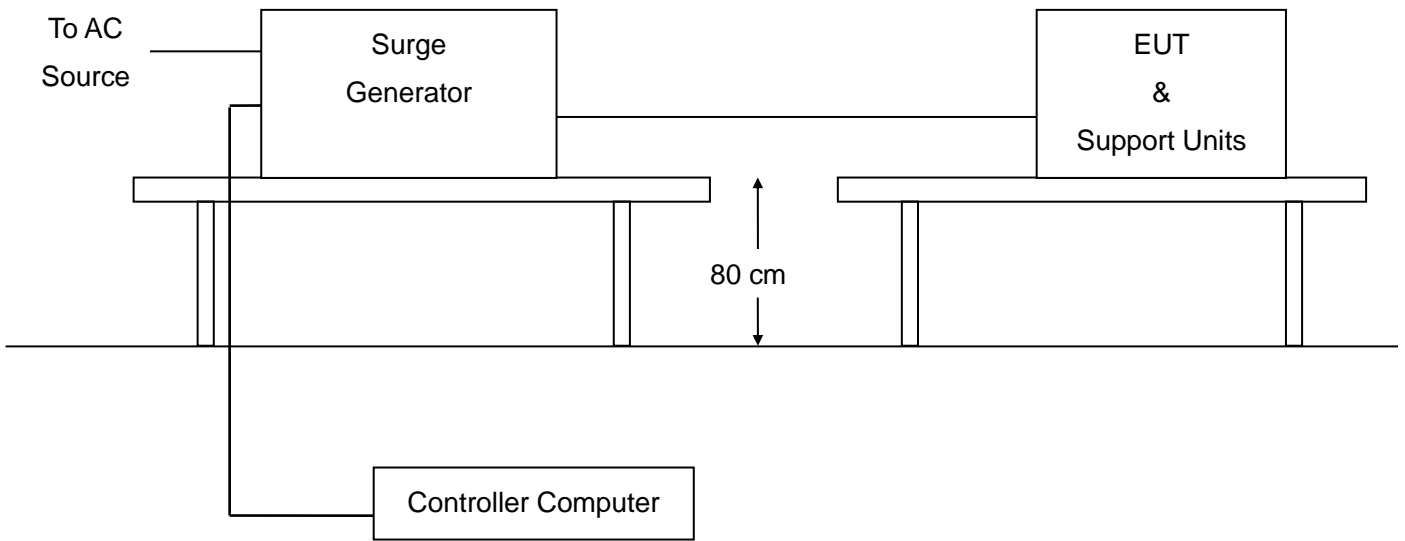

13.3. Equipment Details

Measuring Instruments

Instruments No.	Instruments	Manufacturer	Model	S/N	Cal. Date	Cal. Due
AGC-EM-E008	EFT/Surge/DIPS Generator	Schaffner	Modula 6150	34437	2025-05-08	2026-05-07

Measuring Software

Software No.	Software Name	Manufacturer	Details
AGC-EM-S009	WinModula	Schaffner	For EFT/Surge/Dips Measurement, Version 2.31 c

Any report having not been signed by authorized approver, or having been altered without authorization, or having not been stamped by the "Dedicated Testing/Inspection Stamp" is deemed to be invalid. Copying or excerpting portion of, or altering the content of the report is not permitted without the written authorization of AGC. The test results presented in the report apply only to the tested sample. Any objections to report issued by AGC should be submitted to AGC within 15days after the issuance of the test report. Further enquiry of validity or verification of the test report should be addressed to AGC by agc01@agccert.com.

13.4. Configuration of the EUT and method of measurement

- a. Verification shall be performed. It is preferable to perform the verification prior to the test.
- b. The test shall be performed according to the above requirements and block diagram which shall specify the test setup.
- c. When testing line-to-ground, the lines are tested individually in sequence, if there is no other specification.
- d. The test procedure shall also consider the non-linear current-voltage characteristics of the equipment under test. Therefore, all lower test levels including the selected test level shall be tested.
- e. The test results shall be classified in terms of the loss of function or degradation of performance of the equipment under test, relative to a performance criterion defined in the report.

13.5. Test Summary

Test Engineer	Jimu Lao	Temperature	18.2 °C
Test Date	2025-11-15	Air Pressure	985 Mbar
Test Mode(s)	Mode 1	Relative Humidity	48.2 %
Verdict	Pass		

Test port	Coupling	Voltage(kV)	Observation	Performance
AC Mains Input	line-to-neutral	0.5, 1	No degradation of performance	A

Any report having not been signed by authorized approver, or having been altered without authorization, or having not been stamped by the “Dedicated Testing/Inspection Stamp” is deemed to be invalid. Copying or excerpting portion of, or altering the content of the report is not permitted without the written authorization of AGC. The test results presented in the report apply only to the tested sample. Any objections to report issued by AGC should be submitted to AGC within 15days after the issuance of the test report. Further enquiry of validity or verification of the test report should be addressed to AGC by agc01@agccert.com.

14. Measurement of Voltage dips and interruptions

14.1. Requirements

Port	AC mains power ports		
Basic Standard	IEC 61000-4-11		
Required Performance Criterion	B	B	C
Residual voltage ^a	< 5 %	70 %	< 5 %
Number of cycles ^b	0.5	25 for 50 Hz 30 for 60 Hz	250 for 50 Hz 300 for 60 Hz
Variation/dip repetition	Sequence of three dips/interruptions with an interval of 10 seconds between each test		

Notes:

- Changes to occur at 0 degree crossover point of the voltage waveform. If the EUT does not demonstrate compliance when tested with 0 degree switching, the test shall be repeated with the switching occurring at both 90 degrees and 270 degrees. If the EUT satisfies these alternative requirements, then it fulfils the requirements.
- Apply at only one supply frequency of the EUT.

14.2. Block Diagram of Test Setup

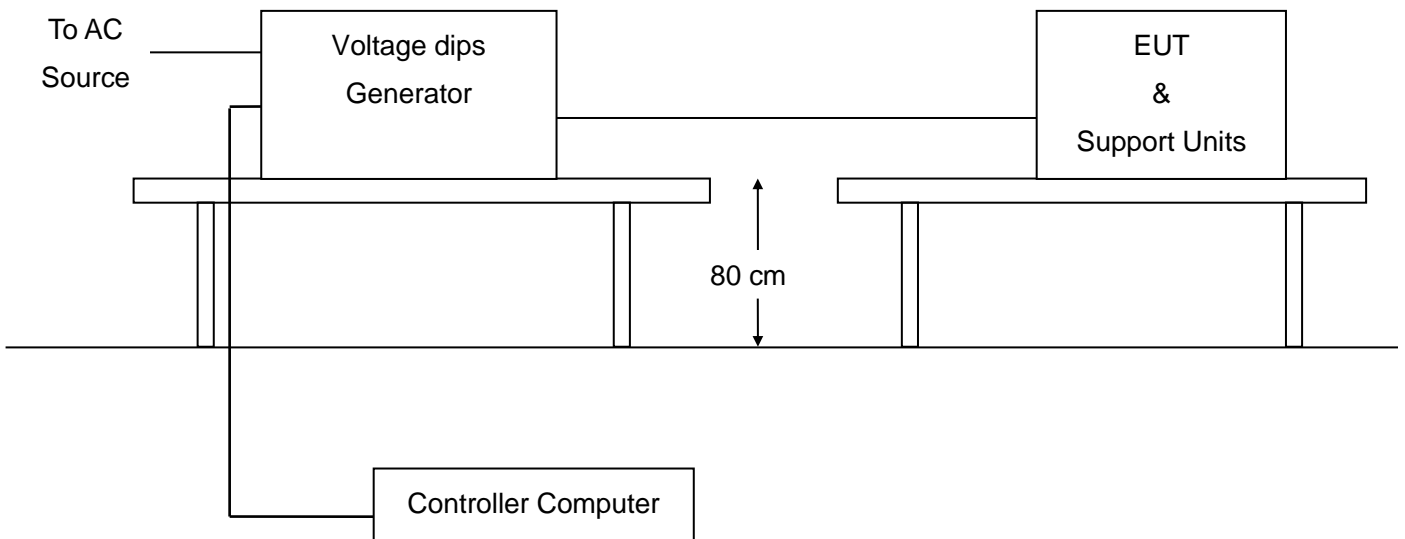

Any report having not been signed by authorized approver, or having been altered without authorization, or having not been stamped by the "Dedicated Testing/Inspection Stamp" is deemed to be invalid. Copying or excerpting portion of, or altering the content of the report is not permitted without the written authorization of AGC. The test results presented in the report apply only to the tested sample. Any objections to report issued by AGC should be submitted to AGC within 15days after the issuance of the test report. Further enquiry of validity or verification of the test report should be addressed to AGC by agc01@agccert.com.

14.3. Equipment Details

Measuring Instruments

Instruments No.	Instruments	Manufacturer	Model	S/N	Cal. Date	Cal. Due
AGC-EM-E008	EFT/Surge/DIPS Generator	Schaffner	Modula 6150	34437	2025-05-08	2026-05-07

Measuring Software

Software No.	Software Name	Manufacturer	Details
AGC-EM-S009	WinModula	Schaffner	For EFT/Surge/Dips Measurement, Version 2.31 c

14.4. Configuration of the EUT and method of measurement

- a. The test shall be performed according to the above requirements and block diagram which shall specify the test setup.
- b. The test results shall be classified in terms of the loss of function or degradation of performance of the equipment under test, relative to a performance criterion defined in the report.

Any report having not been signed by authorized approver, or having been altered without authorization, or having not been stamped by the "Dedicated Testing/Inspection Stamp" is deemed to be invalid. Copying or excerpting portion of, or altering the content of the report is not permitted without the written authorization of AGC. The test results presented in the report apply only to the tested sample. Any objections to report issued by AGC should be submitted to AGC within 15days after the issuance of the test report. Further enquiry of validity or verification of the test report should be addressed to AGC by agc01@agccert.com.

14.5. Test Summary

Test Engineer	Jimu Lao	Temperature	18.2 °C
Test Date	2025-11-15	Air Pressure	985 Mbar
Test Mode(s)	Mode 1	Relative Humidity	48.2 %
Verdict	Pass		

Test port	Residual voltage (%)	Cycles	Observation	Performance
AC Mains Input	< 5	0.5	No degradation of performance	A
	70	25	No degradation of performance	A
	< 5	250	EUT power cycled	B

Any report having not been signed by authorized approver, or having been altered without authorization, or having not been stamped by the “Dedicated Testing/Inspection Stamp” is deemed to be invalid. Copying or excerpting portion of, or altering the content of the report is not permitted without the written authorization of AGC. The test results presented in the report apply only to the tested sample. Any objections to report issued by AGC should be submitted to AGC within 15days after the issuance of the test report. Further enquiry of validity or verification of the test report should be addressed to AGC by agc01@agccert.com.

15. Photographs of Test Setup



Conducted emissions from the AC mains power ports

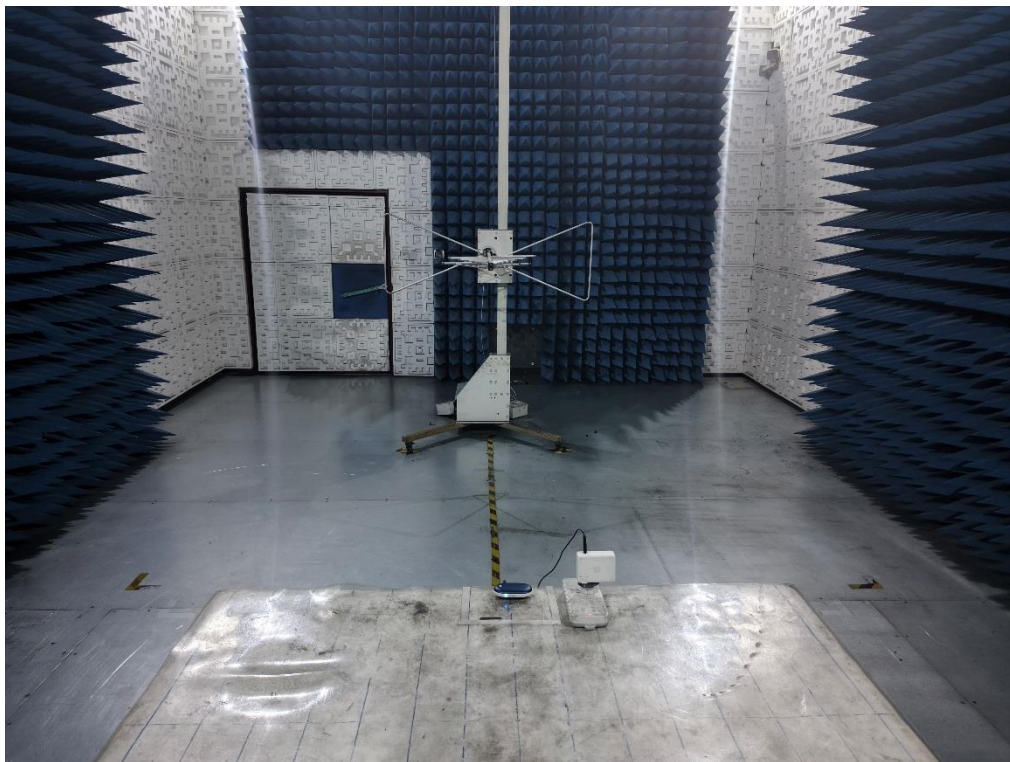

Radiated emissions at frequencies up to 1GHz

Any report having not been signed by authorized approver, or having been altered without authorization, or having not been stamped by the “Dedicated Testing/Inspection Stamp” is deemed to be invalid. Copying or excerpting portion of, or altering the content of the report is not permitted without the written authorization of AGC. The test results presented in the report apply only to the tested sample. Any objections to report issued by AGC should be submitted to AGC within 15days after the issuance of the test report. Further enquiry of validity or verification of the test report should be addressed to AGC by agc01@agccert.com.

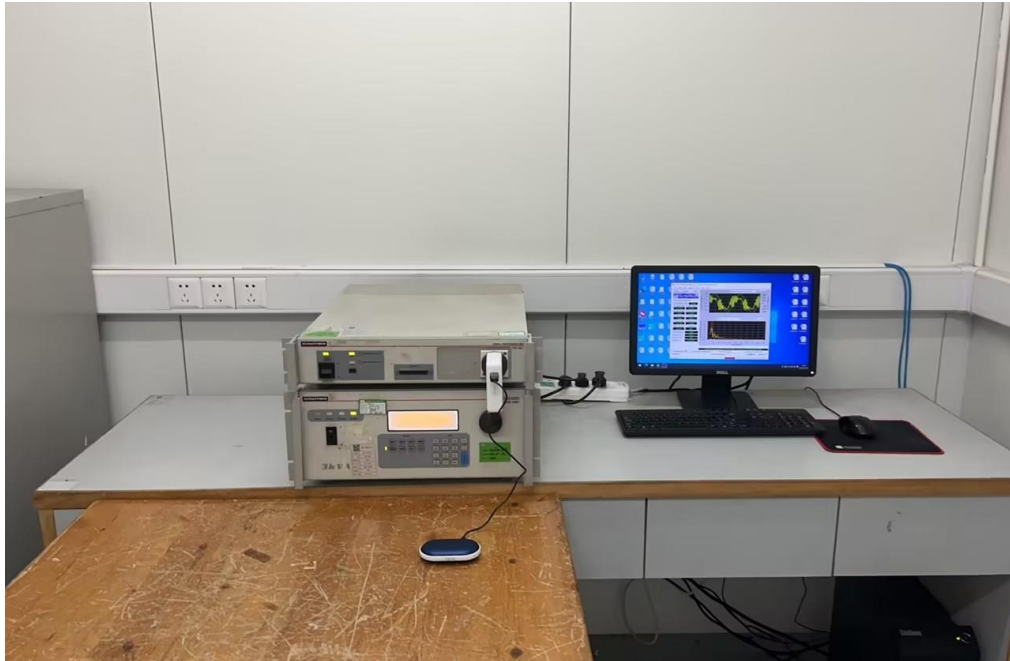

Harmonic Current Emissions & Voltage Fluctuations and Flicker

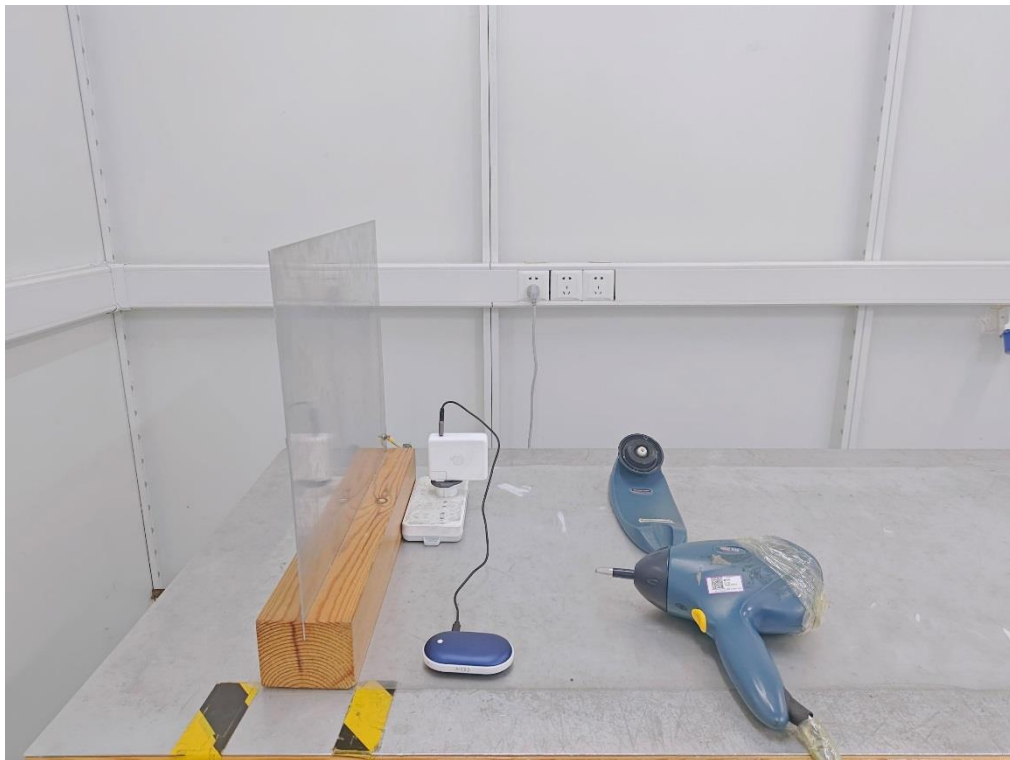

Electrostatic Discharge

Any report having not been signed by authorized approver, or having been altered without authorization, or having not been stamped by the “Dedicated Testing/Inspection Stamp” is deemed to be invalid. Copying or excerpting portion of, or altering the content of the report is not permitted without the written authorization of AGC. The test results presented in the report apply only to the tested sample. Any objections to report issued by AGC should be submitted to AGC within 15days after the issuance of the test report. Further enquiry of validity or verification of the test report should be addressed to AGC by agc01@agccert.com.

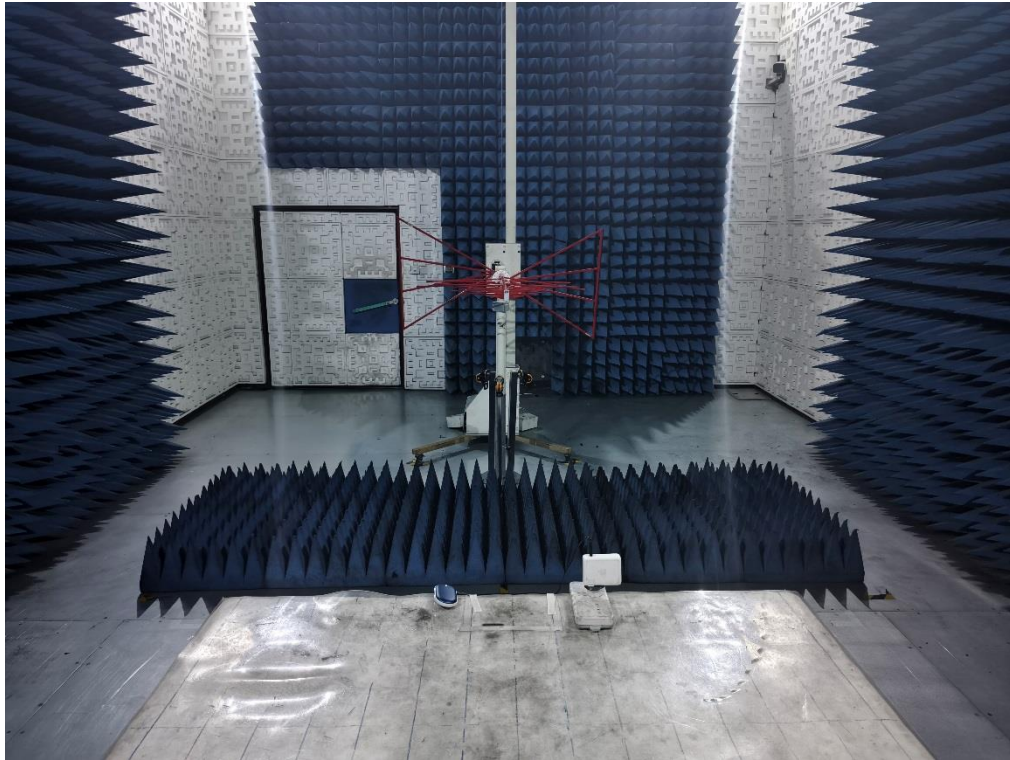

Radio-Frequency Electromagnetic Field up to 1 GHz

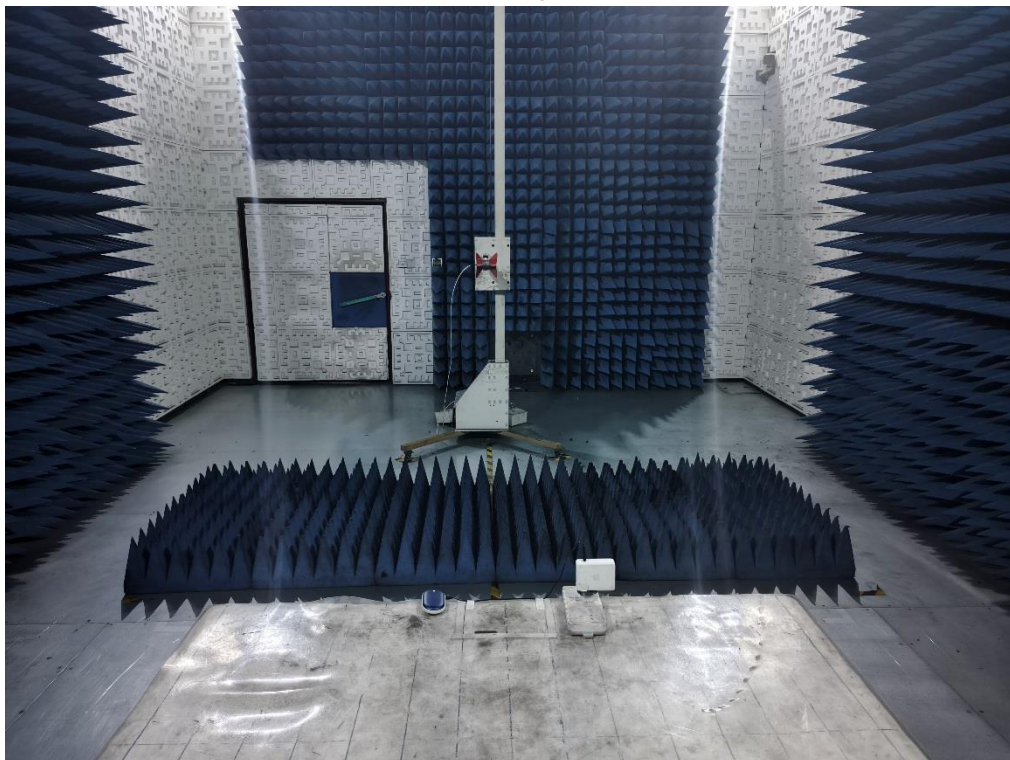

Radio-Frequency Electromagnetic Field Above 1 GHz

Any report having not been signed by authorized approver, or having been altered without authorization, or having not been stamped by the “Dedicated Testing/Inspection Stamp” is deemed to be invalid. Copying or excerpting portion of, or altering the content of the report is not permitted without the written authorization of AGC. The test results presented in the report apply only to the tested sample. Any objections to report issued by AGC should be submitted to AGC within 15days after the issuance of the test report. Further enquiry of validity or verification of the test report should be addressed to AGC by agc01@agccert.com.

Attestation of Global Compliance(Shenzhen)Co., Ltd

Attestation of Global Compliance(Shenzhen)Std & Tech Co., Ltd

Tel: +86-755 2523 4088 E-mail: agc@agccert.com Web: <http://www.agccert.com/>



Radio-Frequency Common Mode at the AC Mains Power Ports

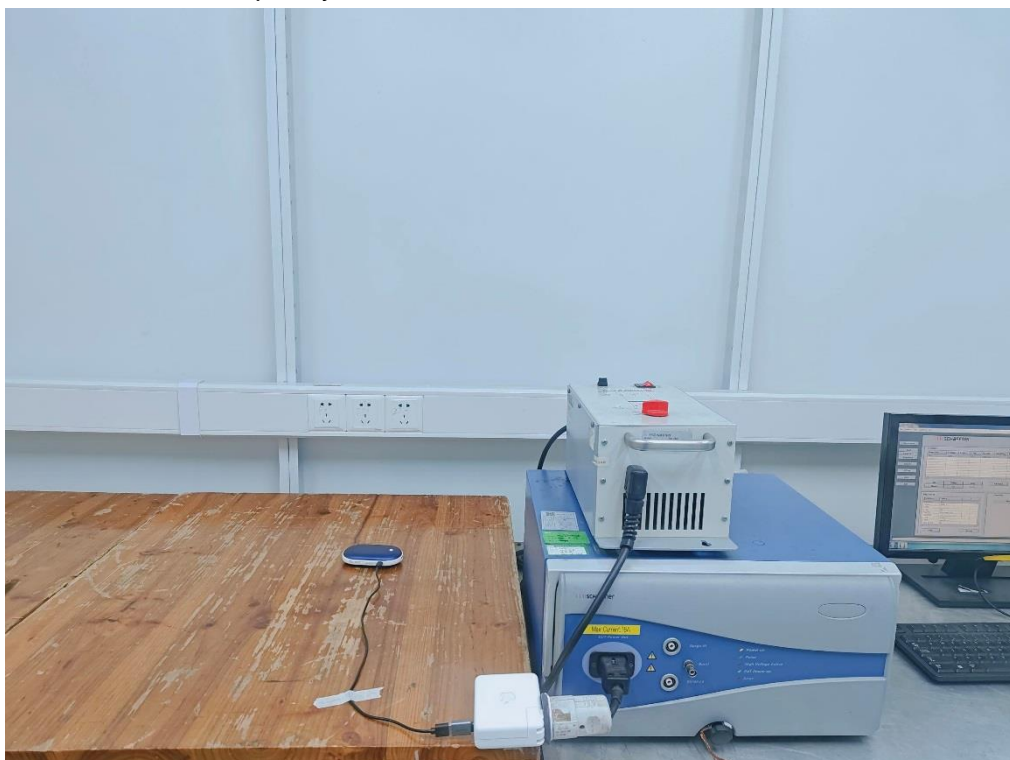

Fast Transients/Surges/ Voltage dips at the AC mains power ports

Any report having not been signed by authorized approver, or having been altered without authorization, or having not been stamped by the "Dedicated Testing/Inspection Stamp" is deemed to be invalid. Copying or excerpting portion of, or altering the content of the report is not permitted without the written authorization of AGC. The test results presented in the report apply only to the tested sample. Any objections to report issued by AGC should be submitted to AGC within 15days after the issuance of the test report. Further enquiry of validity or verification of the test report should be addressed to AGC by agc01@agccert.com.

16. Photographs of EUT



All view-1 of EUT



All view-2 of EUT

Any report having not been signed by authorized approver, or having been altered without authorization, or having not been stamped by the “Dedicated Testing/Inspection Stamp” is deemed to be invalid. Copying or excerpting portion of, or altering the content of the report is not permitted without the written authorization of AGC. The test results presented in the report apply only to the tested sample. Any objections to report issued by AGC should be submitted to AGC within 15days after the issuance of the test report. Further enquiry of validity or verification of the test report should be addressed to AGC by agc01@agccert.com.



All view-3 of EUT



All view-4 of EUT

Any report having not been signed by authorized approver, or having been altered without authorization, or having not been stamped by the “Dedicated Testing/Inspection Stamp” is deemed to be invalid. Copying or excerpting portion of, or altering the content of the report is not permitted without the written authorization of AGC. The test results presented in the report apply only to the tested sample. Any objections to report issued by AGC should be submitted to AGC within 15days after the issuance of the test report. Further enquiry of validity or verification of the test report should be addressed to AGC by agc01@agccert.com.

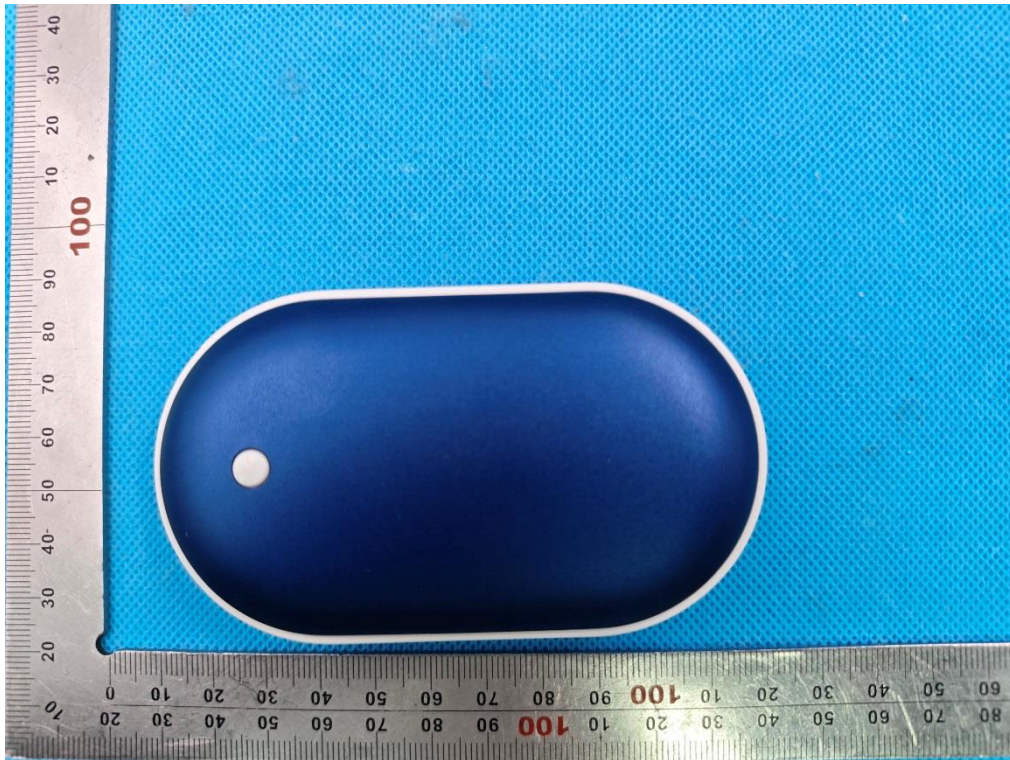

Top view of EUT

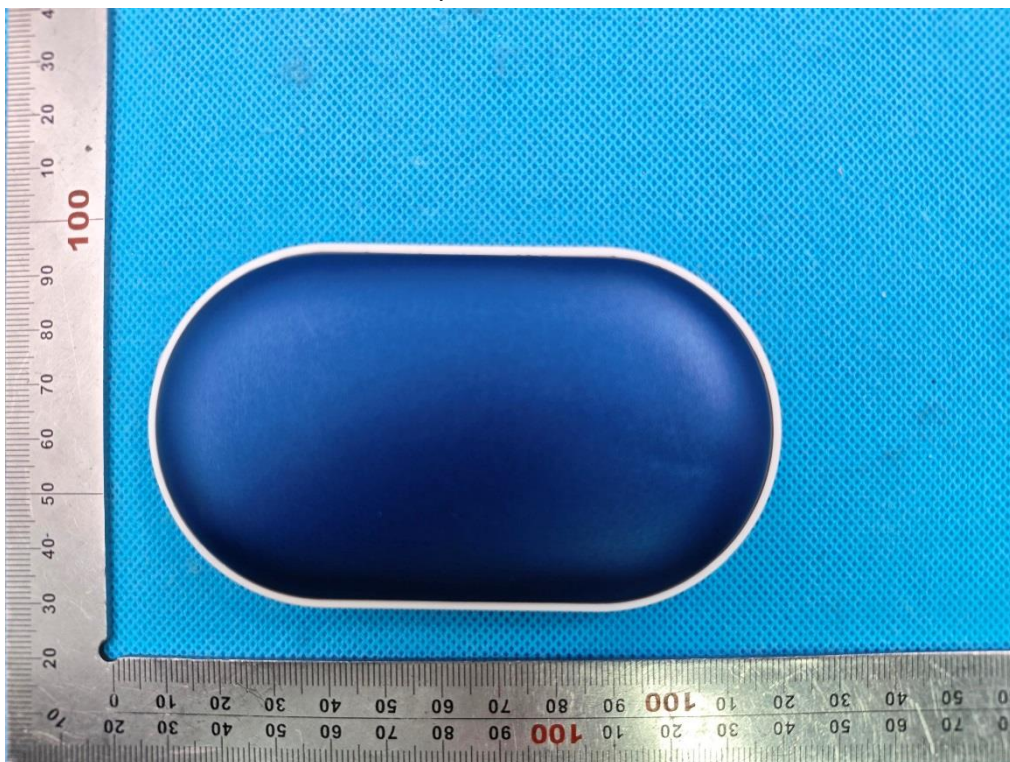

Bottom view of EUT

Any report having not been signed by authorized approver, or having been altered without authorization, or having not been stamped by the “Dedicated Testing/Inspection Stamp” is deemed to be invalid. Copying or excerpting portion of, or altering the content of the report is not permitted without the written authorization of AGC. The test results presented in the report apply only to the tested sample. Any objections to report issued by AGC should be submitted to AGC within 15days after the issuance of the test report. Further enquiry of validity or verification of the test report should be addressed to AGC by agc01@agccert.com.



Front view of EUT



Back view of EUT

Any report having not been signed by authorized approver, or having been altered without authorization, or having not been stamped by the "Dedicated Testing/Inspection Stamp" is deemed to be invalid. Copying or excerpting portion of, or altering the content of the report is not permitted without the written authorization of AGC. The test results presented in the report apply only to the tested sample. Any objections to report issued by AGC should be submitted to AGC within 15days after the issuance of the test report. Further enquiry of validity or verification of the test report should be addressed to AGC by agc01@agccert.com.

Attestation of Global Compliance(Shenzhen)Co., Ltd
Attestation of Global Compliance(Shenzhen)Std & Tech Co., Ltd
Tel: +86-755 2523 4088 E-mail: agc@agccert.com Web: <http://www.agccert.com/>



Left view of EUT



Right view of EUT

Any report having not been signed by authorized approver, or having been altered without authorization, or having not been stamped by the “Dedicated Testing/Inspection Stamp” is deemed to be invalid. Copying or excerpting portion of, or altering the content of the report is not permitted without the written authorization of AGC. The test results presented in the report apply only to the tested sample. Any objections to report issued by AGC should be submitted to AGC within 15days after the issuance of the test report. Further enquiry of validity or verification of the test report should be addressed to AGC by agc01@agccert.com.

Attestation of Global Compliance(Shenzhen)Co., Ltd
Attestation of Global Compliance(Shenzhen)Std & Tech Co., Ltd
Tel: +86-755 2523 4088 E-mail: agc@agccert.com Web: <http://www.agccert.com/>

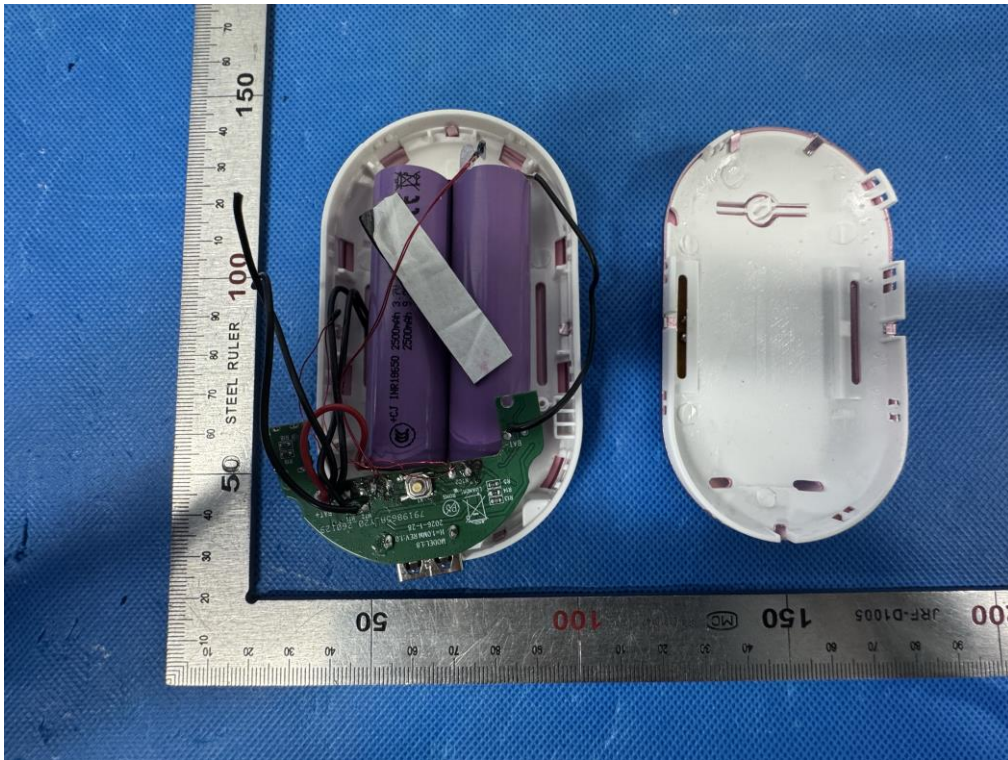

Open view of EUT

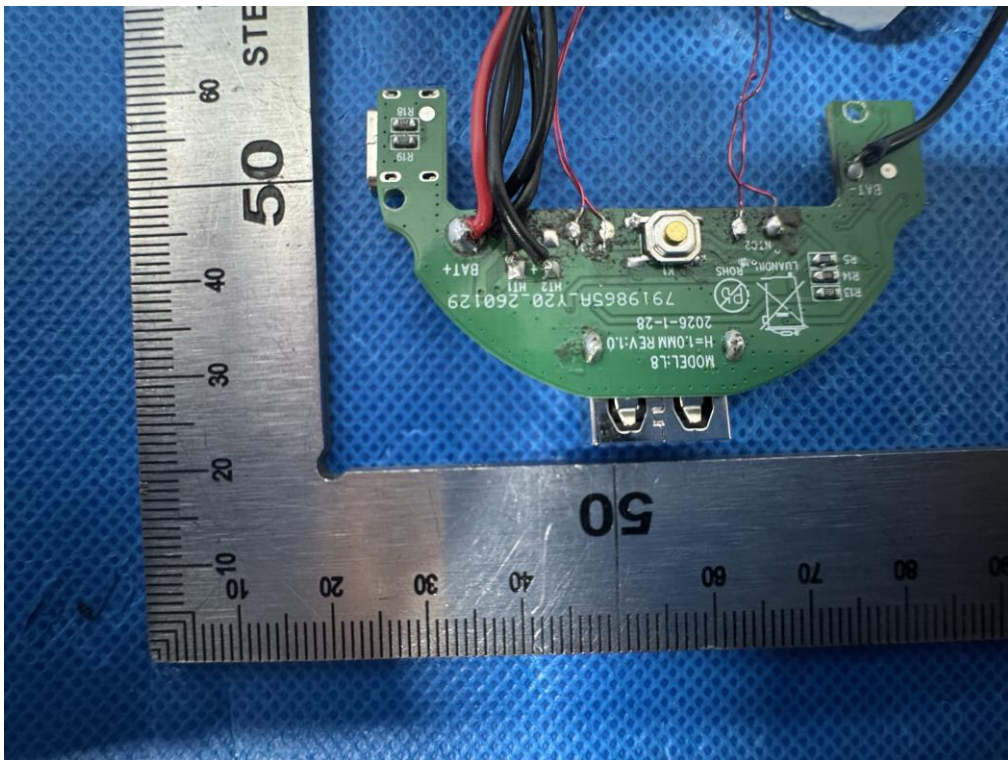

Internal view-1 of EUT

Any report having not been signed by authorized approver, or having been altered without authorization, or having not been stamped by the "Dedicated Testing/Inspection Stamp" is deemed to be invalid. Copying or excerpting portion of, or altering the content of the report is not permitted without the written authorization of AGC. The test results presented in the report apply only to the tested sample. Any objections to report issued by AGC should be submitted to AGC within 15days after the issuance of the test report. Further enquiry of validity or verification of the test report should be addressed to AGC by agc01@agccert.com.

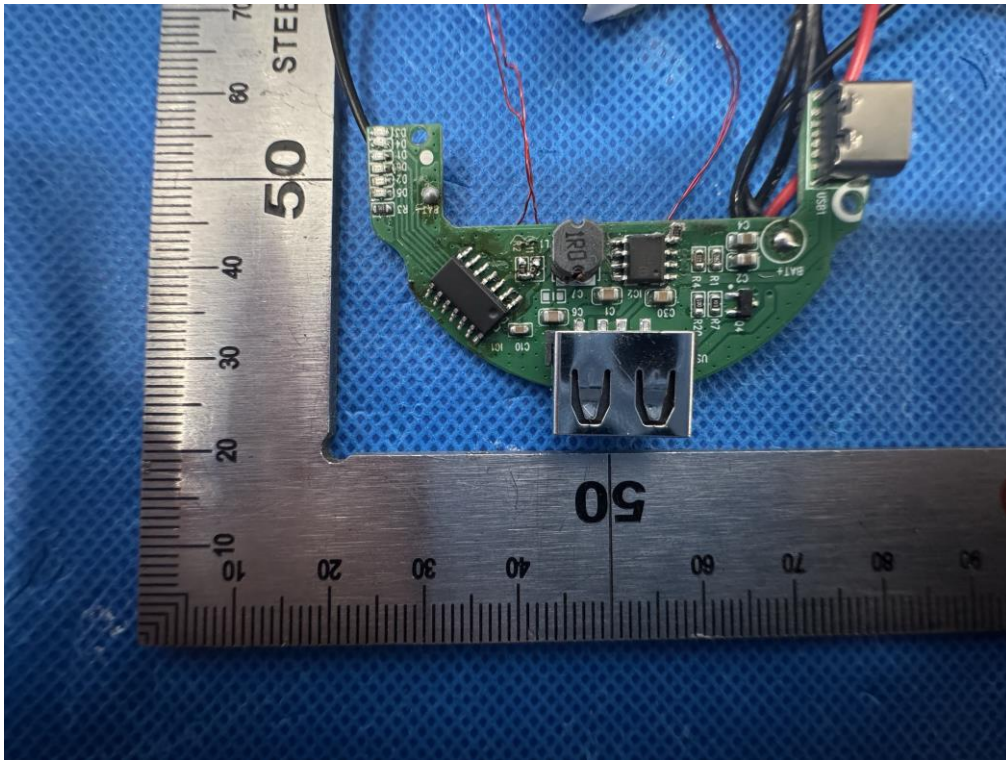

Internal view-2 of EUT



Battery view of EUT

Any report having not been signed by authorized approver, or having been altered without authorization, or having not been stamped by the "Dedicated Testing/Inspection Stamp" is deemed to be invalid. Copying or excerpting portion of, or altering the content of the report is not permitted without the written authorization of AGC. The test results presented in the report apply only to the tested sample. Any objections to report issued by AGC should be submitted to AGC within 15days after the issuance of the test report. Further enquiry of validity or verification of the test report should be addressed to AGC by agc01@agccert.com.

Conditions of Issuance of Test Reports

1. All samples and goods are accepted by the Attestation of Global Compliance (Shenzhen) Co., Ltd (the "Company") solely for testing and reporting in accordance with the following terms and conditions. The company provides its services on the basis that such terms and conditions constitute express agreement between the company and any person, firm or company requesting its services (the "Clients").
2. Any report issued by Company as a result of this application for testing services (the "Report") shall be issued in confidence to the Clients and the Report will be strictly treated as such by the Company. It may not be reproduced either in its entirety or in part and it may not be used for advertising or other unauthorized purposes without the written consent of the Company. The Clients to whom the Report is issued may, however, show or send it, or a certified copy thereof prepared by the Company to its customer, supplier or other persons directly concerned. The Company will not, without the consent of the Clients, enter into any discussion or correspondence with any third party concerning the contents of the Report, unless required by the relevant governmental authorities, laws or court orders.
3. The Company shall not be called or be liable to be called to give evidence or testimony on the Report in a court of law without its prior written consent, unless required by the relevant governmental authorities, laws or court orders.
4. In the event of the improper use of the report as determined by the Company, the Company reserves the right to withdraw it, and to adopt any other additional remedies which may be appropriate.
5. Samples submitted for testing are accepted on the understanding that the Report issued cannot form the basis of, or be the instrument for, any legal action against the Company.
6. The Company will not be liable for or accept responsibility for any loss or damage however arising from the use of information contained in any of its Reports or in any communication whatsoever about its said tests or investigations.
7. Clients wishing to use the Report in court proceedings or arbitration shall inform the Company to that effect prior to submitting the sample for testing.
8. The Company is not responsible for recalling the electronic version of the original report when any revision is made to them. The Client assumes the responsibility to providing the revised version to any interested party who uses them.
9. Subject to the variable length of retention time for test data and report stored hereinto as otherwise specifically required by individual accreditation authorities, the Company will only keep the supporting test data and information of the test report for a period of six years. The data and information will be disposed of after the aforementioned retention period has elapsed. Under no circumstances shall we provide any data and information which has been disposed of after retention period. Under no circumstances shall we be liable for damage of any kind, including (but not limited to) compensatory damages, lost profits, lost data, or any form of special, incidental, indirect, consequential or punitive damages of any kind, whether based on breach of contract of warranty, tort (including negligence), product liability or otherwise, even if we are informed in advance of the possibility of such damages.

----End of Report----

Any report having not been signed by authorized approver, or having been altered without authorization, or having not been stamped by the "Dedicated Testing/Inspection Stamp" is deemed to be invalid. Copying or excerpting portion of, or altering the content of the report is not permitted without the written authorization of AGC. The test results presented in the report apply only to the tested sample. Any objections to report issued by AGC should be submitted to AGC within 15days after the issuance of the test report. Further enquiry of validity or verification of the test report should be addressed to AGC by agc01@agccert.com.