Test Report

Report No. : AGC05443260232-001

SAMPLE NAME : Bamboo USB 3 ports hub
MODEL NAME : MO2143
APPLICANT : MID OCEAN BRANDS B.V.
STANDARD(S) : Please refer to the following page(s).
DATE OF ISSUE : Mar. 10, 2026

Attestation of Global Compliance (Shenzhen) Std & Tech Co., Ltd.



Any report having not been signed by authorized approver, or having been altered without authorization, or having not been stamped by the "Dedicated Testing/Inspection Stamp" is deemed to be invalid. Copying or excerpting portion of, or altering the content of the report is not permitted without the written authorization of AGC. The test results presented in the report apply only to the tested sample. Any objections to report issued by AGC should be submitted to AGC within 15days after the issuance of the test report. Further enquiry of validity or verification of the test report should be addressed to AGC by agc01@agccert.com.

Applicant : MID OCEAN BRANDS B.V.
Address : Unit 711-716, 7/F., Tower A, 83 King Lam Street, Cheung Sha Wan, Kowloon, Hong Kong.
Test Site : 6/F., Building 2, Sanwei Chaxi Industrial Park, Sanwei Community, Hangcheng Street, Bao'an District, Shenzhen, Guangdong, China

Report on the submitted sample(s) said to be:

Sample Name : Bamboo USB 3 ports hub
Model : MO2143
Vendor code : 109979
Country of Origin : CHINA
Country of Destination : EUROPE
Sample Received Date : Feb. 27, 2026
Testing Period : Feb. 27, 2026 to Mar. 09, 2026
Test Requested : Selected test(s) as requested by client.

Test Requested:**Conclusion**

2011/65/EU (RoHS) and its amendment directive (EU) 2015/863
- Pb, Cd, Hg, Cr⁶⁺, PBBs, PBDEs, DBP, BBP, DEHP, DIBP

Pass

Annex XVII of the REACH Regulation (EC) No 1907/2006, entry 77
- Formaldehyde Release

Pass

Regulation (EU) 2019/1021 on persistent organic pollutants (POPs)
- Pentachlorophenol (PCP) Content

Pass

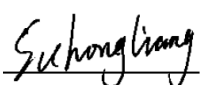
Approved by: 

Suhongliang

Technical Director

Any report having not been signed by authorized approver, or having been altered without authorization, or having not been stamped by the "Dedicated Testing/Inspection Stamp" is deemed to be invalid. Copying or excerpting portion of, or altering the content of the report is not permitted without the written authorization of AGC. The test results presented in the report apply only to the tested sample. Any objections to report issued by AGC should be submitted to AGC within 15days after the issuance of the test report. Further enquiry of validity or verification of the test report should be addressed to AGC by agc01@agccert.com.

Report Revise Record

Report Version	Issued Date	Valid Version	Notes
/	Mar. 10, 2026	Valid	Initial release

Any report having not been signed by authorized approver, or having been altered without authorization, or having not been stamped by the "Dedicated Testing/Inspection Stamp" is deemed to be invalid. Copying or excerpting portion of, or altering the content of the report is not permitted without the written authorization of AGC. The test results presented in the report apply only to the tested sample. Any objections to report issued by AGC should be submitted to AGC within 15days after the issuance of the test report. Further enquiry of validity or verification of the test report should be addressed to AGC by agc01@agccert.com.

Attestation of Global Compliance(Shenzhen)Co., Ltd

Attestation of Global Compliance(Shenzhen)Std & Tech Co., Ltd

Tel: +86-755 2523 4088 E-mail: agc@agccert.com Web: <http://www.agccert.com/>

The photo of the sample

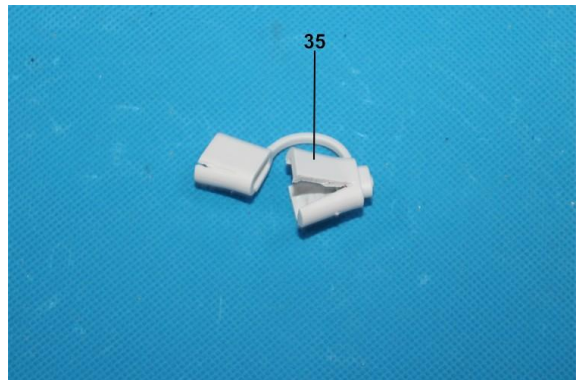
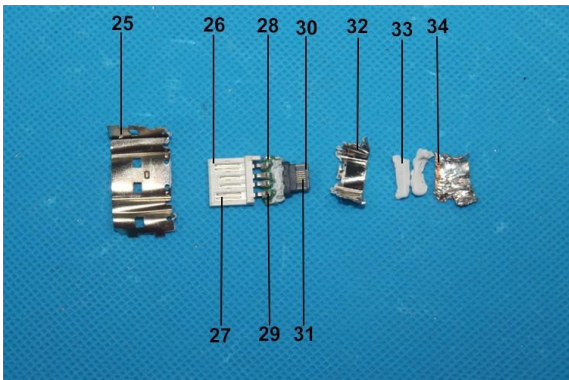
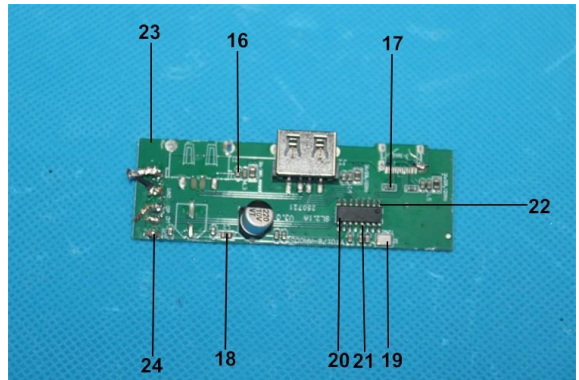
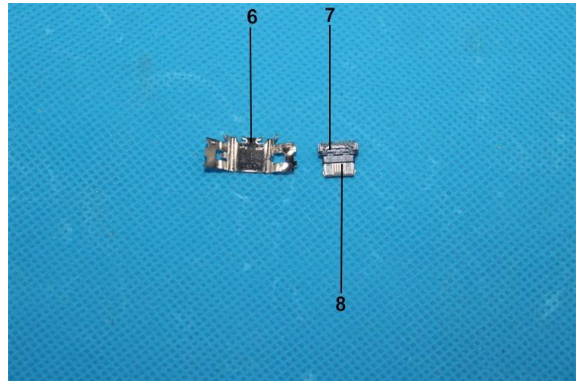
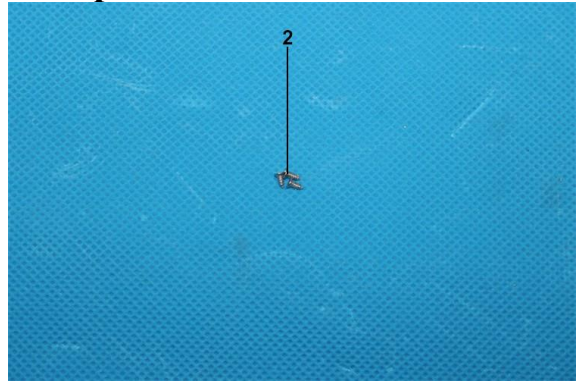

Any report having not been signed by authorized approver, or having been altered without authorization, or having not been stamped by the "Dedicated Testing/Inspection Stamp" is deemed to be invalid. Copying or excerpting portion of, or altering the content of the report is not permitted without the written authorization of AGC. The test results presented in the report apply only to the tested sample. Any objections to report issued by AGC should be submitted to AGC within 15days after the issuance of the test report. Further enquiry of validity or verification of the test report should be addressed to AGC by agc01@agccert.com.

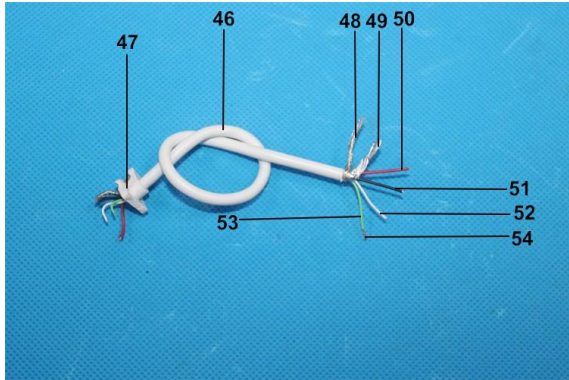
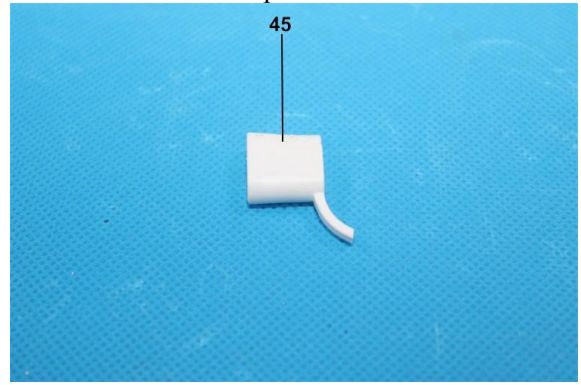
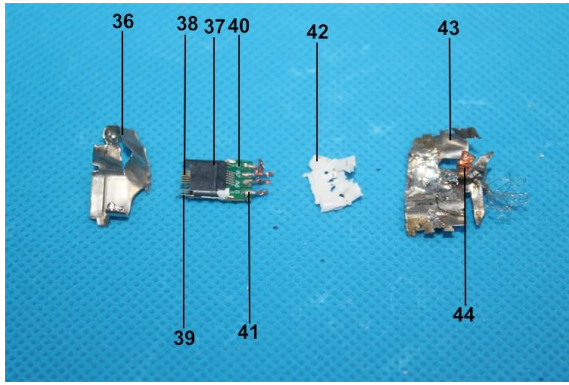

The photo of AGC05443260232-001 is for use only with the original report.

Test Point Description

Test point	Test module	Test parts	Test point description
Bamboo USB 3 ports hub Model : MO2143			
1	---	Outer shell	Woody shell
2	---	---	Silver screw
3	Circuit board	USB device	USB metal device
4			Grey plastic joint
5			Metal pin
6		Type-C connector	Type-C metal connector
7			Grey plastic joint
8			Metal pin
9		Aluminum capacitor	Aluminum shell
10			Positive foil
11			Negative foil
12			Electrolytic paper
13			Black rubber stopper
14			Black plastic base
15			Metal pin
16			---
17		---	Chip resistor

Any report having not been signed by authorized approver, or having been altered without authorization, or having not been stamped by the "Dedicated Testing/Inspection Stamp" is deemed to be invalid. Copying or excerpting portion of, or altering the content of the report is not permitted without the written authorization of AGC. The test results presented in the report apply only to the tested sample. Any objections to report issued by AGC should be submitted to AGC within 15days after the issuance of the test report. Further enquiry of validity or verification of the test report should be addressed to AGC by agc01@agccert.com.

18		---	Chip inductor
19		---	Chip crystal oscillator
20		IC	IC body
21			Solder at the pins
22			Metal pin
23		---	PCB
24		---	Solder
25	---	USB to type-C Plug	USB metal plug
26	---		Grey plastic plug
27	---		Metal pin
28	---		PCB
29	---		Solder
30	---		Grey plastic plug
31	---		Metal pin
32	---		Type-C metal plug
33	---		White inner glue
34	---		Copper foil
35	---	White handle	
36	---	Type-C plug	Type-C metal plug
37	---		Grey plastic plug
38	---		Metal pin
39	---		Metallic pogo pin
40	---		PCB
41	---		Solder
42	---		White inner glue
43	---		Metallic shell
44	---		Copper foil
45	---	White handle	
46	---	Wire rod	White outer wire jacket
47	---		White buckle
48	---		Metallic braided wire
49	---		Aluminum foil
50	---		Red wire jacket
51	---		Black wire jacket
52	---		White wire jacket
53	---		Green wire jacket
54	---		Conductor

Note: "---" = The test point exists alone in the sample and is not attached to the test module or test parts.

Any report having not been signed by authorized approver, or having been altered without authorization, or having not been stamped by the "Dedicated Testing/Inspection Stamp" is deemed to be invalid. Copying or excerpting portion of, or altering the content of the report is not permitted without the written authorization of AGC. The test results presented in the report apply only to the tested sample. Any objections to report issued by AGC should be submitted to AGC within 15days after the issuance of the test report. Further enquiry of validity or verification of the test report should be addressed to AGC by agc01@agccert.com.

Test Results:

Note: N.D.=Not Detected (less than method detection limit), MDL = Method Detection Limit, 1mg/kg=0.0001%,
N/A= Not Applicable

Unless otherwise stated, the decision rule for conformity reporting is based on Binary Statement for Simple Acceptance Rule (w=0) stated in ILAC-G8:09/2019/CNAS-GL015:2022.

2011/65/EU (RoHS) and its amendment directive (EU) 2015/863
- Pb, Cd, Hg, Cr⁶⁺, PBBs, PBDEs, DBP, BBP, DEHP, DIBP

Test Item	Test Method/ Instrument	MDL	Maximum Limit
Lead (Pb)	IEC 62321-3-1:2013/ XRF	/	1000mg/kg
Cadmium (Cd)		/	100mg/kg
Mercury (Hg)		/	1000mg/kg
Total Chromium		/	/
Total Bromine		/	/
Chemistry Method			
Lead (Pb)	IEC 62321-5:2013/ ICP-OES	2mg/kg	1000mg/kg
Cadmium (Cd)	IEC 62321-5:2013/ ICP-OES	2mg/kg	100mg/kg
Mercury (Hg)	IEC 62321-4: 2013+A1:2017/ ICP-OES	2mg/kg	1000mg/kg
Non-metal: Hexavalent Chromium (Cr ⁶⁺)	IEC 62321-7-2:2017/ UV-Vis	8mg/kg	1000mg/kg
Metal: Hexavalent Chromium (Cr ⁶⁺)	IEC 62321-7-1:2015/ UV-Vis	0.1µg/cm ²	/
Polybrominated Biphenyls (PBBs) -Monobromobiphenyl (MonoBB) -Dibromobiphenyl (DiBB) -Tribromobiphenyl (TriBB) -Tetrabromobiphenyl (TetraBB) -Pentabromobiphenyl (PentaBB) -Hexabromobiphenyl (HexaBB) -Heptabromobiphenyl (HeptaBB) -Octabromobiphenyl (OctaBB) -Nonabromodiphenyl (NonaBB) -Decabromodiphenyl (DecaBB)	IEC 62321-6:2015/ GC-MS	Single 5mg/kg	Sum 1000mg/kg
Polybrominated Diphenylethers (PBDEs) -Monobromodiphenyl ether (MonoBDE) -Dibromodiphenyl ether (DiBDE) -Tribromodiphenyl ether (TriBDE) -Tetrabromodiphenyl ether (TetraBDE) -Pentabromodiphenyl ether (PentaBDE) -Hexabromodiphenyl ether (HexaBDE) -Heptabromodiphenyl ether (HeptaBDE) -Octabromodiphenyl ether (OctaBDE) -Nonabromodiphenyl ether (NonaBDE) -Decabromodiphenyl ether (DecaBDE)	IEC 62321-6:2015/ GC-MS	Single 5mg/kg	Sum 1000mg/kg
Di-iso-butyl phthalate (DIBP)	IEC 62321-8:2017/ GC-MS	50mg/kg	1000mg/kg
Dibutyl phthalate (DBP)		50mg/kg	1000mg/kg
Butylbenzyl phthalate (BBP)		50mg/kg	1000mg/kg
Di-(2-ethylhexyl) Phthalate (DEHP)		50mg/kg	1000mg/kg

Any report having not been signed by authorized approver, or having been altered without authorization, or having not been stamped by the "Dedicated Testing/Inspection Stamp" is deemed to be invalid. Copying or excerpting portion of, or altering the content of the report is not permitted without the written authorization of AGC. The test results presented in the report apply only to the tested sample. Any objections to report issued by AGC should be submitted to AGC within 15days after the issuance of the test report. Further enquiry of validity or verification of the test report should be addressed to AGC by agc01@agccert.com.

Test point	Test Item	X-ray Fluorescence Spectrometry (XRF) mg/kg	Wet Chemistry Method mg/kg	Conclusion	
1	Pb	BL	/	Conformity	
	Cd	BL	/		
	Hg	BL	/		
	Cr(Cr ⁶⁺)	BL	/		
	Br	PBBs	BL		/
		PBDEs			/
	DIBP	N/A	N.D.		
	DBP	N/A	N.D.		
	BBP	N/A	N.D.		
DEHP	N/A	N.D.			
2	Pb	BL	/	Conformity	
	Cd	BL	/		
	Hg	BL	/		
	Cr(Cr ⁶⁺)	BL	/		
	Br	PBBs	N/A		/
		PBDEs			/
	DIBP	N/A	/		
	DBP	N/A	/		
	BBP	N/A	/		
DEHP	N/A	/			
3	Pb	BL	/	Conformity	
	Cd	BL	/		
	Hg	BL	/		
	Cr(Cr ⁶⁺)	BL	/		
	Br	PBBs	N/A		/
		PBDEs			/
	DIBP	N/A	/		
	DBP	N/A	/		
	BBP	N/A	/		
DEHP	N/A	/			
4	Pb	BL	/	Conformity	
	Cd	BL	/		
	Hg	BL	/		
	Cr(Cr ⁶⁺)	BL	/		
	Br	PBBs	BL		/
		PBDEs			/
	DIBP	N/A	N.D.		
	DBP	N/A	N.D.		
	BBP	N/A	N.D.		
DEHP	N/A	N.D.			

Any report having not been signed by authorized approver, or having been altered without authorization, or having not been stamped by the "Dedicated Testing/Inspection Stamp" is deemed to be invalid. Copying or excerpting portion of, or altering the content of the report is not permitted without the written authorization of AGC. The test results presented in the report apply only to the tested sample. Any objections to report issued by AGC should be submitted to AGC within 15days after the issuance of the test report. Further enquiry of validity or verification of the test report should be addressed to AGC by agc01@agccert.com.

Attestation of Global Compliance(Shenzhen)Co., Ltd

Attestation of Global Compliance(Shenzhen)Std & Tech Co., Ltd

Tel: +86-755 2523 4088 E-mail: agc@agccert.com Web: http://www.agccert.com/

Test point	Test Item	X-ray Fluorescence Spectrometry (XRF) mg/kg	Wet Chemistry Method mg/kg	Conclusion	
5	Pb	BL	/	Conformity	
	Cd	BL	/		
	Hg	BL	/		
	Cr(Cr ⁶⁺)	BL	/		
	Br	PBBs	N/A		/
		PBDEs			/
	DIBP	N/A	/		
	DBP	N/A	/		
	BBP	N/A	/		
DEHP	N/A	/			
6	Pb	BL	/	Conformity	
	Cd	BL	/		
	Hg	BL	/		
	Cr(Cr ⁶⁺)	IN	N.D.		
	Br	PBBs	N/A		/
		PBDEs			/
	DIBP	N/A	/		
	DBP	N/A	/		
	BBP	N/A	/		
DEHP	N/A	/			
7	Pb	BL	/	Conformity	
	Cd	BL	/		
	Hg	BL	/		
	Cr(Cr ⁶⁺)	BL	/		
	Br	PBBs	BL		/
		PBDEs			/
	DIBP	N/A	N.D.		
	DBP	N/A	N.D.		
	BBP	N/A	N.D.		
DEHP	N/A	N.D.			
8	Pb	BL	/	Conformity	
	Cd	BL	/		
	Hg	BL	/		
	Cr(Cr ⁶⁺)	BL	/		
	Br	PBBs	N/A		/
		PBDEs			/
	DIBP	N/A	/		
	DBP	N/A	/		
	BBP	N/A	/		
DEHP	N/A	/			

Any report having not been signed by authorized approver, or having been altered without authorization, or having not been stamped by the "Dedicated Testing/Inspection Stamp" is deemed to be invalid. Copying or excerpting portion of, or altering the content of the report is not permitted without the written authorization of AGC. The test results presented in the report apply only to the tested sample. Any objections to report issued by AGC should be submitted to AGC within 15days after the issuance of the test report. Further enquiry of validity or verification of the test report should be addressed to AGC by agc01@agccert.com.

Attestation of Global Compliance(Shenzhen)Co., Ltd

Attestation of Global Compliance(Shenzhen)Std & Tech Co., Ltd

Tel: +86-755 2523 4088 E-mail: agc@agccert.com Web: http://www.agccert.com/

Test point	Test Item	X-ray Fluorescence Spectrometry (XRF) mg/kg	Wet Chemistry Method mg/kg	Conclusion	
9	Pb	BL	/	Conformity	
	Cd	BL	/		
	Hg	BL	/		
	Cr(Cr ⁶⁺)	BL	/		
	Br	PBBs	N/A		/
		PBDEs			/
	DIBP	N/A	/		
	DBP	N/A	/		
	BBP	N/A	/		
DEHP	N/A	/			
10	Pb	BL	/	Conformity	
	Cd	BL	/		
	Hg	BL	/		
	Cr(Cr ⁶⁺)	BL	/		
	Br	PBBs	N/A		/
		PBDEs			/
	DIBP	N/A	/		
	DBP	N/A	/		
	BBP	N/A	/		
DEHP	N/A	/			
11	Pb	BL	/	Conformity	
	Cd	BL	/		
	Hg	BL	/		
	Cr(Cr ⁶⁺)	BL	/		
	Br	PBBs	N/A		/
		PBDEs			/
	DIBP	N/A	/		
	DBP	N/A	/		
	BBP	N/A	/		
DEHP	N/A	/			
12	Pb	BL	/	Conformity	
	Cd	BL	/		
	Hg	BL	/		
	Cr(Cr ⁶⁺)	BL	/		
	Br	PBBs	BL		/
		PBDEs			/
	DIBP	N/A	N.D.		
	DBP	N/A	N.D.		
	BBP	N/A	N.D.		
DEHP	N/A	N.D.			

Any report having not been signed by authorized approver, or having been altered without authorization, or having not been stamped by the "Dedicated Testing/Inspection Stamp" is deemed to be invalid. Copying or excerpting portion of, or altering the content of the report is not permitted without the written authorization of AGC. The test results presented in the report apply only to the tested sample. Any objections to report issued by AGC should be submitted to AGC within 15days after the issuance of the test report. Further enquiry of validity or verification of the test report should be addressed to AGC by agc01@agccert.com.

Attestation of Global Compliance(Shenzhen)Co., Ltd

Attestation of Global Compliance(Shenzhen)Std & Tech Co., Ltd

Tel: +86-755 2523 4088 E-mail: agc@agccert.com Web: http://www.agccert.com/

Test point	Test Item	X-ray Fluorescence Spectrometry (XRF) mg/kg	Wet Chemistry Method mg/kg	Conclusion	
13	Pb	BL	/	Conformity	
	Cd	BL	/		
	Hg	BL	/		
	Cr(Cr ⁶⁺)	BL	/		
	Br	PBBs	BL		/
		PBDEs			/
	DIBP	N/A	N.D.		
	DBP	N/A	N.D.		
	BBP	N/A	N.D.		
DEHP	N/A	N.D.			
14	Pb	BL	/	Conformity	
	Cd	BL	/		
	Hg	BL	/		
	Cr(Cr ⁶⁺)	BL	/		
	Br	PBBs	BL		/
		PBDEs			/
	DIBP	N/A	N.D.		
	DBP	N/A	N.D.		
	BBP	N/A	N.D.		
DEHP	N/A	N.D.			
15	Pb	BL	/	Conformity	
	Cd	BL	/		
	Hg	BL	/		
	Cr(Cr ⁶⁺)	BL	/		
	Br	PBBs	N/A		/
		PBDEs			/
	DIBP	N/A	/		
	DBP	N/A	/		
	BBP	N/A	/		
DEHP	N/A	/			
16	Pb	BL	/	Conformity	
	Cd	BL	/		
	Hg	BL	/		
	Cr(Cr ⁶⁺)	BL	/		
	Br	PBBs	BL		/
		PBDEs			/
	DIBP	N/A	N.D.		
	DBP	N/A	N.D.		
	BBP	N/A	N.D.		
DEHP	N/A	N.D.			

Any report having not been signed by authorized approver, or having been altered without authorization, or having not been stamped by the "Dedicated Testing/Inspection Stamp" is deemed to be invalid. Copying or excerpting portion of, or altering the content of the report is not permitted without the written authorization of AGC. The test results presented in the report apply only to the tested sample. Any objections to report issued by AGC should be submitted to AGC within 15days after the issuance of the test report. Further enquiry of validity or verification of the test report should be addressed to AGC by agc01@agccert.com.

Attestation of Global Compliance(Shenzhen)Co., Ltd

Attestation of Global Compliance(Shenzhen)Std & Tech Co., Ltd

Tel: +86-755 2523 4088 E-mail: agc@agccert.com Web: http://www.agccert.com/

Test point	Test Item	X-ray Fluorescence Spectrometry (XRF) mg/kg	Wet Chemistry Method mg/kg	Conclusion	
17	Pb	BL	/	Conformity	
	Cd	BL	/		
	Hg	BL	/		
	Cr(Cr ⁶⁺)	IN	N.D.		
	Br	PBBs	BL		/
		PBDEs			/
	DIBP	N/A	N.D.		
	DBP	N/A	N.D.		
	BBP	N/A	N.D.		
DEHP	N/A	N.D.			
18	Pb	BL	/	Conformity	
	Cd	BL	/		
	Hg	BL	/		
	Cr(Cr ⁶⁺)	BL	/		
	Br	PBBs	BL		/
		PBDEs			/
	DIBP	N/A	N.D.		
	DBP	N/A	N.D.		
	BBP	N/A	N.D.		
DEHP	N/A	N.D.			
19	Pb	BL	/	Conformity	
	Cd	BL	/		
	Hg	BL	/		
	Cr(Cr ⁶⁺)	BL	/		
	Br	PBBs	BL		/
		PBDEs			/
	DIBP	N/A	N.D.		
	DBP	N/A	N.D.		
	BBP	N/A	N.D.		
DEHP	N/A	N.D.			
20	Pb	BL	/	Conformity	
	Cd	BL	/		
	Hg	BL	/		
	Cr(Cr ⁶⁺)	BL	/		
	Br	PBBs	BL		/
		PBDEs			/
	DIBP	N/A	N.D.		
	DBP	N/A	N.D.		
	BBP	N/A	N.D.		
DEHP	N/A	N.D.			

Any report having not been signed by authorized approver, or having been altered without authorization, or having not been stamped by the "Dedicated Testing/Inspection Stamp" is deemed to be invalid. Copying or excerpting portion of, or altering the content of the report is not permitted without the written authorization of AGC. The test results presented in the report apply only to the tested sample. Any objections to report issued by AGC should be submitted to AGC within 15days after the issuance of the test report. Further enquiry of validity or verification of the test report should be addressed to AGC by agc01@agccert.com.

Attestation of Global Compliance(Shenzhen)Co., Ltd

Attestation of Global Compliance(Shenzhen)Std & Tech Co., Ltd

Tel: +86-755 2523 4088 E-mail: agc@agccert.com Web: http://www.agccert.com/

Test point	Test Item	X-ray Fluorescence Spectrometry (XRF) mg/kg	Wet Chemistry Method mg/kg	Conclusion	
21	Pb	BL	/	Conformity	
	Cd	BL	/		
	Hg	BL	/		
	Cr(Cr ⁶⁺)	BL	/		
	Br	PBBs	N/A		/
		PBDEs			/
	DIBP	N/A	/		
	DBP	N/A	/		
	BBP	N/A	/		
DEHP	N/A	/			
22	Pb	BL	/	Conformity	
	Cd	BL	/		
	Hg	BL	/		
	Cr(Cr ⁶⁺)	BL	/		
	Br	PBBs	N/A		/
		PBDEs			/
	DIBP	N/A	/		
	DBP	N/A	/		
	BBP	N/A	/		
DEHP	N/A	/			
23	Pb	BL	/	Conformity	
	Cd	BL	/		
	Hg	BL	/		
	Cr(Cr ⁶⁺)	BL	/		
	Br	PBBs	IN		N.D.
		PBDEs			N.D.
	DIBP	N/A	N.D.		
	DBP	N/A	N.D.		
	BBP	N/A	N.D.		
DEHP	N/A	N.D.			
24	Pb	BL	/	Conformity	
	Cd	BL	/		
	Hg	BL	/		
	Cr(Cr ⁶⁺)	BL	/		
	Br	PBBs	N/A		/
		PBDEs			/
	DIBP	N/A	/		
	DBP	N/A	/		
	BBP	N/A	/		
DEHP	N/A	/			

Any report having not been signed by authorized approver, or having been altered without authorization, or having not been stamped by the "Dedicated Testing/Inspection Stamp" is deemed to be invalid. Copying or excerpting portion of, or altering the content of the report is not permitted without the written authorization of AGC. The test results presented in the report apply only to the tested sample. Any objections to report issued by AGC should be submitted to AGC within 15days after the issuance of the test report. Further enquiry of validity or verification of the test report should be addressed to AGC by agc01@agccert.com.

Attestation of Global Compliance(Shenzhen)Co., Ltd

Attestation of Global Compliance(Shenzhen)Std & Tech Co., Ltd

Tel: +86-755 2523 4088 E-mail: agc@agccert.com Web: http://www.agccert.com/

Test point	Test Item	X-ray Fluorescence Spectrometry (XRF) mg/kg	Wet Chemistry Method mg/kg	Conclusion	
25	Pb	BL	/	Conformity	
	Cd	BL	/		
	Hg	BL	/		
	Cr(Cr ⁶⁺)	BL	/		
	Br	PBBs	N/A		/
		PBDEs			/
	DIBP	N/A	/		
	DBP	N/A	/		
	BBP	N/A	/		
DEHP	N/A	/			
26	Pb	BL	/	Conformity	
	Cd	BL	/		
	Hg	BL	/		
	Cr(Cr ⁶⁺)	BL	/		
	Br	PBBs	BL		/
		PBDEs			/
	DIBP	N/A	N.D.		
	DBP	N/A	N.D.		
	BBP	N/A	N.D.		
DEHP	N/A	N.D.			
27	Pb	BL	/	Conformity	
	Cd	BL	/		
	Hg	BL	/		
	Cr(Cr ⁶⁺)	BL	/		
	Br	PBBs	N/A		/
		PBDEs			/
	DIBP	N/A	/		
	DBP	N/A	/		
	BBP	N/A	/		
DEHP	N/A	/			
28	Pb	BL	/	Conformity	
	Cd	BL	/		
	Hg	BL	/		
	Cr(Cr ⁶⁺)	BL	/		
	Br	PBBs	IN		N.D.
		PBDEs			N.D.
	DIBP	N/A	N.D.		
	DBP	N/A	N.D.		
	BBP	N/A	N.D.		
DEHP	N/A	N.D.			

Any report having not been signed by authorized approver, or having been altered without authorization, or having not been stamped by the "Dedicated Testing/Inspection Stamp" is deemed to be invalid. Copying or excerpting portion of, or altering the content of the report is not permitted without the written authorization of AGC. The test results presented in the report apply only to the tested sample. Any objections to report issued by AGC should be submitted to AGC within 15days after the issuance of the test report. Further enquiry of validity or verification of the test report should be addressed to AGC by agc01@agccert.com.

Attestation of Global Compliance(Shenzhen)Co., Ltd

Attestation of Global Compliance(Shenzhen)Std & Tech Co., Ltd

Tel: +86-755 2523 4088 E-mail: agc@agccert.com Web: http://www.agccert.com/

Test point	Test Item	X-ray Fluorescence Spectrometry (XRF) mg/kg	Wet Chemistry Method mg/kg	Conclusion	
29	Pb	BL	/	Conformity	
	Cd	BL	/		
	Hg	BL	/		
	Cr(Cr ⁶⁺)	BL	/		
	Br	PBBs	N/A		/
		PBDEs			/
	DIBP	N/A	/		
	DBP	N/A	/		
	BBP	N/A	/		
DEHP	N/A	/			
30	Pb	BL	/	Conformity	
	Cd	BL	/		
	Hg	BL	/		
	Cr(Cr ⁶⁺)	BL	/		
	Br	PBBs	BL		/
		PBDEs			/
	DIBP	N/A	N.D.		
	DBP	N/A	N.D.		
	BBP	N/A	N.D.		
DEHP	N/A	N.D.			
31	Pb	BL	/	Conformity	
	Cd	BL	/		
	Hg	BL	/		
	Cr(Cr ⁶⁺)	BL	/		
	Br	PBBs	N/A		/
		PBDEs			/
	DIBP	N/A	/		
	DBP	N/A	/		
	BBP	N/A	/		
DEHP	N/A	/			
32	Pb	BL	/	Conformity	
	Cd	BL	/		
	Hg	BL	/		
	Cr(Cr ⁶⁺)	IN	N.D.		
	Br	PBBs	N/A		/
		PBDEs			/
	DIBP	N/A	/		
	DBP	N/A	/		
	BBP	N/A	/		
DEHP	N/A	/			

Any report having not been signed by authorized approver, or having been altered without authorization, or having not been stamped by the "Dedicated Testing/Inspection Stamp" is deemed to be invalid. Copying or excerpting portion of, or altering the content of the report is not permitted without the written authorization of AGC. The test results presented in the report apply only to the tested sample. Any objections to report issued by AGC should be submitted to AGC within 15days after the issuance of the test report. Further enquiry of validity or verification of the test report should be addressed to AGC by agc01@agccert.com.

Test point	Test Item	X-ray Fluorescence Spectrometry (XRF) mg/kg	Wet Chemistry Method mg/kg	Conclusion	
33	Pb	BL	/	Conformity	
	Cd	BL	/		
	Hg	BL	/		
	Cr(Cr ⁶⁺)	BL	/		
	Br	PBBs	BL		/
		PBDEs			/
	DIBP	N/A	N.D.		
	DBP	N/A	N.D.		
	BBP	N/A	N.D.		
DEHP	N/A	N.D.			
34	Pb	BL	/	Conformity	
	Cd	BL	/		
	Hg	BL	/		
	Cr(Cr ⁶⁺)	BL	/		
	Br	PBBs	N/A		/
		PBDEs			/
	DIBP	N/A	/		
	DBP	N/A	/		
	BBP	N/A	/		
DEHP	N/A	/			
35	Pb	BL	/	Conformity	
	Cd	BL	/		
	Hg	BL	/		
	Cr(Cr ⁶⁺)	BL	/		
	Br	PBBs	BL		/
		PBDEs			/
	DIBP	N/A	N.D.		
	DBP	N/A	N.D.		
	BBP	N/A	N.D.		
DEHP	N/A	N.D.			
36	Pb	BL	/	Conformity	
	Cd	BL	/		
	Hg	BL	/		
	Cr(Cr ⁶⁺)	IN	N.D.		
	Br	PBBs	N/A		/
		PBDEs			/
	DIBP	N/A	/		
	DBP	N/A	/		
	BBP	N/A	/		
DEHP	N/A	/			

Any report having not been signed by authorized approver, or having been altered without authorization, or having not been stamped by the "Dedicated Testing/Inspection Stamp" is deemed to be invalid. Copying or excerpting portion of, or altering the content of the report is not permitted without the written authorization of AGC. The test results presented in the report apply only to the tested sample. Any objections to report issued by AGC should be submitted to AGC within 15days after the issuance of the test report. Further enquiry of validity or verification of the test report should be addressed to AGC by agc01@agccert.com.

Attestation of Global Compliance(Shenzhen)Co., Ltd

Attestation of Global Compliance(Shenzhen)Std & Tech Co., Ltd

Tel: +86-755 2523 4088 E-mail: agc@agccert.com Web: http://www.agccert.com/

Test point	Test Item	X-ray Fluorescence Spectrometry (XRF) mg/kg	Wet Chemistry Method mg/kg	Conclusion	
37	Pb	BL	/	Conformity	
	Cd	BL	/		
	Hg	BL	/		
	Cr(Cr ⁶⁺)	BL	/		
	Br	PBBs	BL		/
		PBDEs			/
	DIBP	N/A	N.D.		
	DBP	N/A	N.D.		
	BBP	N/A	N.D.		
DEHP	N/A	N.D.			
38	Pb	BL	/	Conformity	
	Cd	BL	/		
	Hg	BL	/		
	Cr(Cr ⁶⁺)	BL	/		
	Br	PBBs	N/A		/
		PBDEs			/
	DIBP	N/A	/		
	DBP	N/A	/		
	BBP	N/A	/		
DEHP	N/A	/			
39	Pb	BL	/	Conformity	
	Cd	BL	/		
	Hg	BL	/		
	Cr(Cr ⁶⁺)	BL	/		
	Br	PBBs	N/A		/
		PBDEs			/
	DIBP	N/A	/		
	DBP	N/A	/		
	BBP	N/A	/		
DEHP	N/A	/			
40	Pb	BL	/	Conformity	
	Cd	BL	/		
	Hg	BL	/		
	Cr(Cr ⁶⁺)	BL	/		
	Br	PBBs	IN		N.D.
		PBDEs			N.D.
	DIBP	N/A	N.D.		
	DBP	N/A	N.D.		
	BBP	N/A	N.D.		
DEHP	N/A	N.D.			

Any report having not been signed by authorized approver, or having been altered without authorization, or having not been stamped by the "Dedicated Testing/Inspection Stamp" is deemed to be invalid. Copying or excerpting portion of, or altering the content of the report is not permitted without the written authorization of AGC. The test results presented in the report apply only to the tested sample. Any objections to report issued by AGC should be submitted to AGC within 15days after the issuance of the test report. Further enquiry of validity or verification of the test report should be addressed to AGC by agc01@agccert.com.

Attestation of Global Compliance(Shenzhen)Co., Ltd

Attestation of Global Compliance(Shenzhen)Std & Tech Co., Ltd

Tel: +86-755 2523 4088 E-mail: agc@agccert.com Web: http://www.agccert.com/

Test point	Test Item	X-ray Fluorescence Spectrometry (XRF) mg/kg	Wet Chemistry Method mg/kg	Conclusion	
41	Pb	BL	/	Conformity	
	Cd	BL	/		
	Hg	BL	/		
	Cr(Cr ⁶⁺)	BL	/		
	Br	PBBs	N/A		/
		PBDEs			/
	DIBP	N/A	/		
	DBP	N/A	/		
	BBP	N/A	/		
DEHP	N/A	/			
42	Pb	BL	/	Conformity	
	Cd	BL	/		
	Hg	BL	/		
	Cr(Cr ⁶⁺)	BL	/		
	Br	PBBs	BL		/
		PBDEs			/
	DIBP	N/A	N.D.		
	DBP	N/A	N.D.		
	BBP	N/A	N.D.		
DEHP	N/A	N.D.			
43	Pb	BL	/	Conformity	
	Cd	BL	/		
	Hg	BL	/		
	Cr(Cr ⁶⁺)	IN	N.D.		
	Br	PBBs	N/A		/
		PBDEs			/
	DIBP	N/A	/		
	DBP	N/A	/		
	BBP	N/A	/		
DEHP	N/A	/			
44	Pb	BL	/	Conformity	
	Cd	BL	/		
	Hg	BL	/		
	Cr(Cr ⁶⁺)	BL	/		
	Br	PBBs	N/A		/
		PBDEs			/
	DIBP	N/A	/		
	DBP	N/A	/		
	BBP	N/A	/		
DEHP	N/A	/			

Any report having not been signed by authorized approver, or having been altered without authorization, or having not been stamped by the "Dedicated Testing/Inspection Stamp" is deemed to be invalid. Copying or excerpting portion of, or altering the content of the report is not permitted without the written authorization of AGC. The test results presented in the report apply only to the tested sample. Any objections to report issued by AGC should be submitted to AGC within 15days after the issuance of the test report. Further enquiry of validity or verification of the test report should be addressed to AGC by agc01@agccert.com.

Attestation of Global Compliance(Shenzhen)Co., Ltd

Attestation of Global Compliance(Shenzhen)Std & Tech Co., Ltd

Tel: +86-755 2523 4088 E-mail: agc@agccert.com Web: http://www.agccert.com/

Test point	Test Item	X-ray Fluorescence Spectrometry (XRF) mg/kg	Wet Chemistry Method mg/kg	Conclusion	
45	Pb	BL	/	Conformity	
	Cd	BL	/		
	Hg	BL	/		
	Cr(Cr ⁶⁺)	BL	/		
	Br	PBBs	BL		/
		PBDEs			/
	DIBP	N/A	N.D.		
	DBP	N/A	N.D.		
	BBP	N/A	N.D.		
DEHP	N/A	N.D.			
46	Pb	BL	/	Conformity	
	Cd	BL	/		
	Hg	BL	/		
	Cr(Cr ⁶⁺)	BL	/		
	Br	PBBs	BL		/
		PBDEs			/
	DIBP	N/A	N.D.		
	DBP	N/A	N.D.		
	BBP	N/A	N.D.		
DEHP	N/A	N.D.			
47	Pb	BL	/	Conformity	
	Cd	BL	/		
	Hg	BL	/		
	Cr(Cr ⁶⁺)	BL	/		
	Br	PBBs	BL		/
		PBDEs			/
	DIBP	N/A	N.D.		
	DBP	N/A	N.D.		
	BBP	N/A	N.D.		
DEHP	N/A	N.D.			
48	Pb	BL	/	Conformity	
	Cd	BL	/		
	Hg	BL	/		
	Cr(Cr ⁶⁺)	BL	/		
	Br	PBBs	N/A		/
		PBDEs			/
	DIBP	N/A	/		
	DBP	N/A	/		
	BBP	N/A	/		
DEHP	N/A	/			

Any report having not been signed by authorized approver, or having been altered without authorization, or having not been stamped by the "Dedicated Testing/Inspection Stamp" is deemed to be invalid. Copying or excerpting portion of, or altering the content of the report is not permitted without the written authorization of AGC. The test results presented in the report apply only to the tested sample. Any objections to report issued by AGC should be submitted to AGC within 15days after the issuance of the test report. Further enquiry of validity or verification of the test report should be addressed to AGC by agc01@agccert.com.

Attestation of Global Compliance(Shenzhen)Co., Ltd

Attestation of Global Compliance(Shenzhen)Std & Tech Co., Ltd

Tel: +86-755 2523 4088 E-mail: agc@agccert.com Web: http://www.agccert.com/

Test point	Test Item	X-ray Fluorescence Spectrometry (XRF) mg/kg	Wet Chemistry Method mg/kg	Conclusion	
49	Pb	BL	/	Conformity	
	Cd	BL	/		
	Hg	BL	/		
	Cr(Cr ⁶⁺)	BL	/		
	Br	PBBs	N/A		/
		PBDEs			/
	DIBP	N/A	/		
	DBP	N/A	/		
	BBP	N/A	/		
DEHP	N/A	/			
50	Pb	BL	/	Conformity	
	Cd	BL	/		
	Hg	BL	/		
	Cr(Cr ⁶⁺)	BL	/		
	Br	PBBs	BL		/
		PBDEs			/
	DIBP	N/A	N.D.		
	DBP	N/A	N.D.		
	BBP	N/A	N.D.		
DEHP	N/A	N.D.			
51	Pb	BL	/	Conformity	
	Cd	BL	/		
	Hg	BL	/		
	Cr(Cr ⁶⁺)	BL	/		
	Br	PBBs	BL		/
		PBDEs			/
	DIBP	N/A	N.D.		
	DBP	N/A	N.D.		
	BBP	N/A	N.D.		
DEHP	N/A	N.D.			
52	Pb	BL	/	Conformity	
	Cd	BL	/		
	Hg	BL	/		
	Cr(Cr ⁶⁺)	BL	/		
	Br	PBBs	BL		/
		PBDEs			/
	DIBP	N/A	N.D.		
	DBP	N/A	N.D.		
	BBP	N/A	N.D.		
DEHP	N/A	N.D.			

Any report having not been signed by authorized approver, or having been altered without authorization, or having not been stamped by the "Dedicated Testing/Inspection Stamp" is deemed to be invalid. Copying or excerpting portion of, or altering the content of the report is not permitted without the written authorization of AGC. The test results presented in the report apply only to the tested sample. Any objections to report issued by AGC should be submitted to AGC within 15days after the issuance of the test report. Further enquiry of validity or verification of the test report should be addressed to AGC by agc01@agccert.com.

Attestation of Global Compliance(Shenzhen)Co., Ltd

Attestation of Global Compliance(Shenzhen)Std & Tech Co., Ltd

Tel: +86-755 2523 4088 E-mail: agc@agccert.com Web: http://www.agccert.com/

Test point	Test Item	X-ray Fluorescence Spectrometry (XRF) mg/kg	Wet Chemistry Method mg/kg	Conclusion	
53	Pb	BL	/	Conformity	
	Cd	BL	/		
	Hg	BL	/		
	Cr(Cr ⁶⁺)	BL	/		
	Br	PBBs	BL		/
		PBDEs			/
	DIBP	N/A	N.D.		
	DBP	N/A	N.D.		
	BBP	N/A	N.D.		
DEHP	N/A	N.D.			
54	Pb	BL	/	Conformity	
	Cd	BL	/		
	Hg	BL	/		
	Cr(Cr ⁶⁺)	BL	/		
	Br	PBBs	N/A		/
		PBDEs			/
	DIBP	N/A	/		
	DBP	N/A	/		
	BBP	N/A	/		
DEHP	N/A	/			

Element	Unit	Non-metal	Metal	Composite Material
Cd	mg/kg	BL≤70-3σ<X <130+3σ≤OL	BL≤70-3σ<X <130+3σ≤OL	BL≤50-3σ<X <150+3σ≤OL
Pb	mg/kg	BL≤700-3σ<X <1300+3σ≤OL	BL≤700-3σ<X <1300+3σ≤OL	BL≤500-3σ<X <1500+3σ≤OL
Hg	mg/kg	BL≤700-3σ<X <1300+3σ≤OL	BL≤700-3σ<X <1300+3σ≤OL	BL≤500-3σ<X <1500+3σ≤OL
Cr	mg/kg	BL≤700-3σ<X	BL≤700-3σ<X	BL≤500-3σ<X
Br	mg/kg	BL≤300-3σ<X	N/A	BL≤250-3σ<X

Remark:

- (1) BL= Below Limit, OL= Over limited, IN = Inconclusive, Scanning by XRF and detected by chemical method, N/A = Not applicable.
- (2) Results were obtained by XRF for primary scanning, and further chemical testing by ICP (for Cd, Pb, Hg), UV-Vis (for Cr(VI)) and GC-MS (for PBBs, PBDEs) are recommended to be performed, if the concentration exceeds the above warning value.
- (3) The XRF scanning test for RoHS elements – The reading may be different to the actual content in the sample be of non-uniformity composition.

Any report having not been signed by authorized approver, or having been altered without authorization, or having not been stamped by the "Dedicated Testing/Inspection Stamp" is deemed to be invalid. Copying or excerpting portion of, or altering the content of the report is not permitted without the written authorization of AGC. The test results presented in the report apply only to the tested sample. Any objections to report issued by AGC should be submitted to AGC within 15days after the issuance of the test report. Further enquiry of validity or verification of the test report should be addressed to AGC by agc01@agccert.com.

(4) Boiling-water-extraction:(X represents the results of the tested sample)

Number	Colorimetric result (Cr(VI) concentration)	Judgement
1	$X < 0.1 \mu\text{g}/\text{cm}^2$	Negative
2	$0.1 \mu\text{g}/\text{cm}^2 \leq X \leq 0.13 \mu\text{g}/\text{cm}^2$	Uncertainty
3	$X > 0.13 \mu\text{g}/\text{cm}^2$	Positive

Negative indicates the absence of Cr(VI) on the tested areas concentration is below the limit of quantification. The coating is considered a non-Cr(VI) based coating.

Uncertainty indicates the absence of Cr(VI) on the tested areas unavoidable coating variations may influence the determination.

Positive indicates the presence of Cr(VI) on the tested areas concentration is above the limit of quantification and the statistical margin of error. The sample coating is considered to contain Cr(VI).

Storage conditions and production date of the tested sample are unavailable and thus result of Cr(VI) represent status of the sample at the time of testing.

(5) This XRF Scanning report is for reference purposes only. The applicant shall make its/his/her own judgment as to whether the information provided in this XRF screening report is sufficient for its/his/her purposes.

The result shown in this XRF scanning report will differ based on various factors, including but not limited to, the sample size, thickness, area, surface flatness, equipment parameters and matrix effect (e.g. plastic, rubber, metal, glass, ceramic etc.). Further wet chemical pre-treatment with relevant chemical equipment analysis are required to obtain quantitative data.

Annex XVII of the REACH Regulation (EC) No 1907/2006, entry 77
- Formaldehyde Release

Test Methods and Equipment: EN 717-1:2004; UV-Vis

Test Item(s)	Unit	Limit	MDL	Test Result(s)
				1
Formaldehyde Release	mg/m ³	0.062	0.006	N.D.(240h)
Conclusion				Conformity

Regulation (EU) 2019/1021 on persistent organic pollutants (POPs)
- Pentachlorophenol (PCP) Content

Test Methods and Equipment: EPA 3550C:2007 & EPA 8270E:2018; GC-MS

Test Item(s)	Unit	Limit	MDL	Test Result(s)
				1
Pentachlorophenol (PCP)	mg/kg	5	5	N.D.
Conclusion				Conformity

Any report having not been signed by authorized approver, or having been altered without authorization, or having not been stamped by the "Dedicated Testing/Inspection Stamp" is deemed to be invalid. Copying or excerpting portion of, or altering the content of the report is not permitted without the written authorization of AGC. The test results presented in the report apply only to the tested sample. Any objections to report issued by AGC should be submitted to AGC within 15days after the issuance of the test report. Further enquiry of validity or verification of the test report should be addressed to AGC by agc01@agccert.com.

Attestation of Global Compliance(Shenzhen)Co., Ltd

Attestation of Global Compliance(Shenzhen)Std & Tech Co., Ltd

Tel: +86-755 2523 4088 E-mail: agc@agccert.com Web: http://www.agccert.com/

Test Flow Chart of XRF

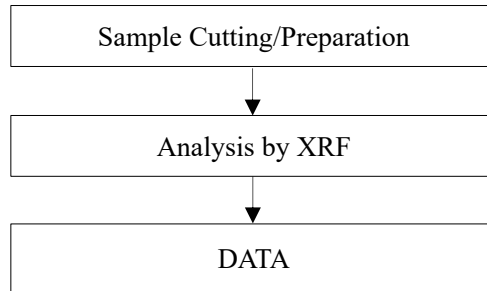

Test Flow Chart of Phthalates

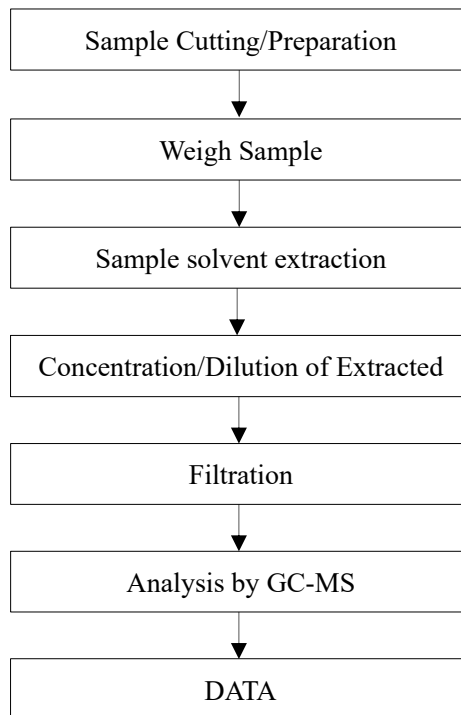

Any report having not been signed by authorized approver, or having been altered without authorization, or having not been stamped by the “Dedicated Testing/Inspection Stamp” is deemed to be invalid. Copying or excerpting portion of, or altering the content of the report is not permitted without the written authorization of AGC. The test results presented in the report apply only to the tested sample. Any objections to report issued by AGC should be submitted to AGC within 15days after the issuance of the test report. Further enquiry of validity or verification of the test report should be addressed to AGC by agc01@agccert.com.

Attestation of Global Compliance(Shenzhen)Co., Ltd

Attestation of Global Compliance(Shenzhen)Std & Tech Co., Ltd

Tel: +86-755 2523 4088 E-mail: agc@agccert.com Web: <http://www.agccert.com/>

Test Flow Chart of Hexavalent Chromium (Cr⁶⁺)

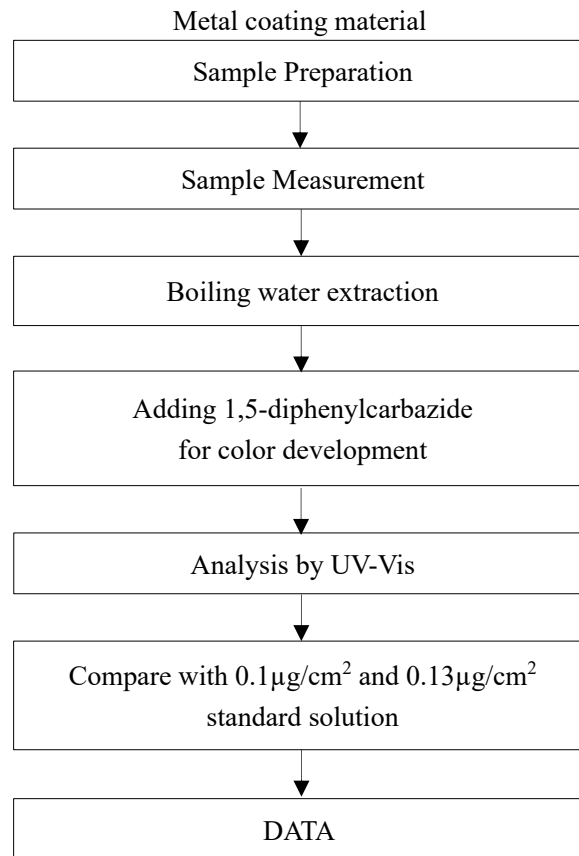

Any report having not been signed by authorized approver, or having been altered without authorization, or having not been stamped by the “Dedicated Testing/Inspection Stamp” is deemed to be invalid. Copying or excerpting portion of, or altering the content of the report is not permitted without the written authorization of AGC. The test results presented in the report apply only to the tested sample. Any objections to report issued by AGC should be submitted to AGC within 15days after the issuance of the test report. Further enquiry of validity or verification of the test report should be addressed to AGC by agc01@agccert.com.

Test Flow Chart of Hexavalent Chromium (Cr⁶⁺)

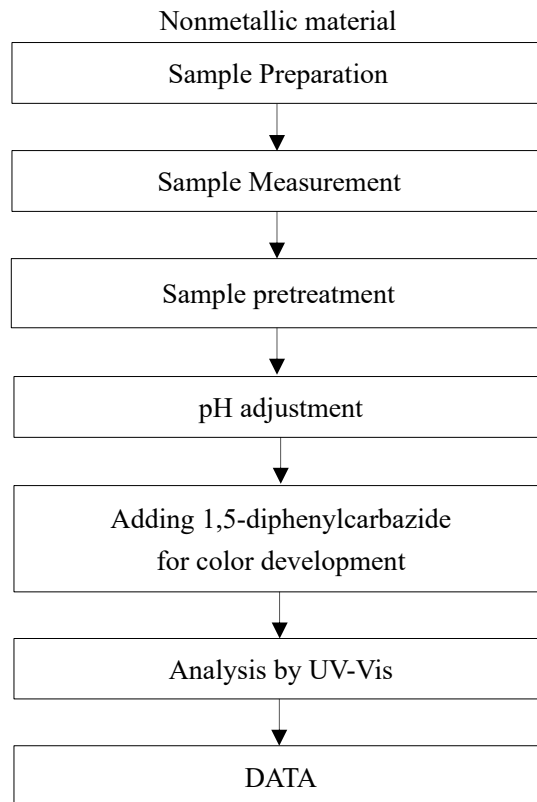

Any report having not been signed by authorized approver, or having been altered without authorization, or having not been stamped by the "Dedicated Testing/Inspection Stamp" is deemed to be invalid. Copying or excerpting portion of, or altering the content of the report is not permitted without the written authorization of AGC. The test results presented in the report apply only to the tested sample. Any objections to report issued by AGC should be submitted to AGC within 15days after the issuance of the test report. Further enquiry of validity or verification of the test report should be addressed to AGC by agc01@agccert.com.

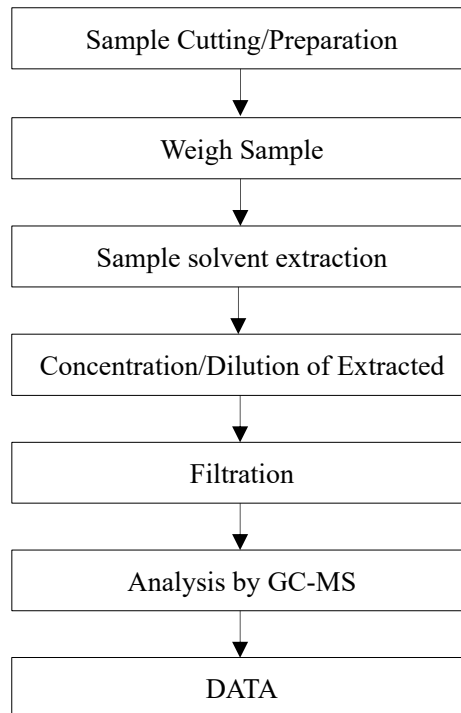
Test Flow Chart of PBBs and PBDEs

Any report having not been signed by authorized approver, or having been altered without authorization, or having not been stamped by the “Dedicated Testing/Inspection Stamp” is deemed to be invalid. Copying or excerpting portion of, or altering the content of the report is not permitted without the written authorization of AGC. The test results presented in the report apply only to the tested sample. Any objections to report issued by AGC should be submitted to AGC within 15days after the issuance of the test report. Further enquiry of validity or verification of the test report should be addressed to AGC by agc01@agccert.com.

Test Flow Chart of Formaldehyde Release

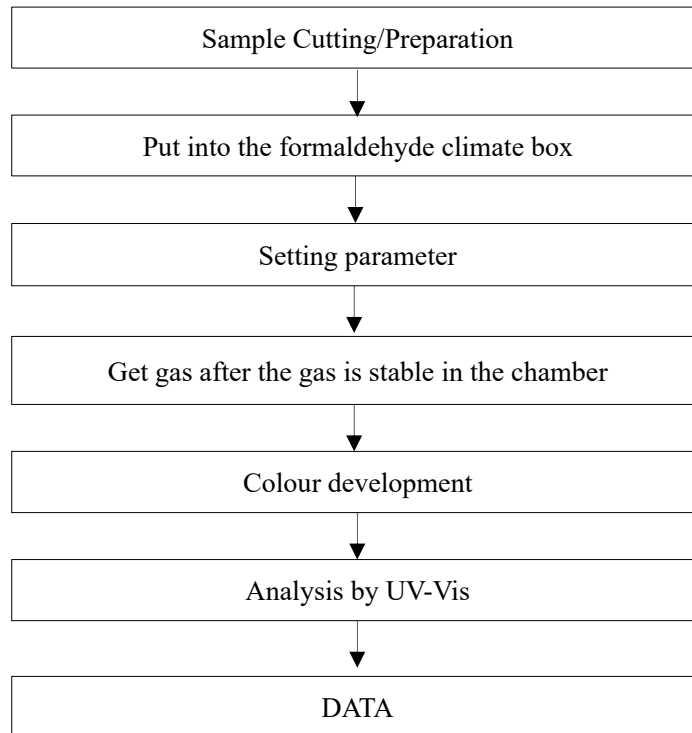

Any report having not been signed by authorized approver, or having been altered without authorization, or having not been stamped by the “Dedicated Testing/Inspection Stamp” is deemed to be invalid. Copying or excerpting portion of, or altering the content of the report is not permitted without the written authorization of AGC. The test results presented in the report apply only to the tested sample. Any objections to report issued by AGC should be submitted to AGC within 15days after the issuance of the test report. Further enquiry of validity or verification of the test report should be addressed to AGC by agc01@agccert.com.

Test Flow Chart of Pentachlorophenol (PCP)

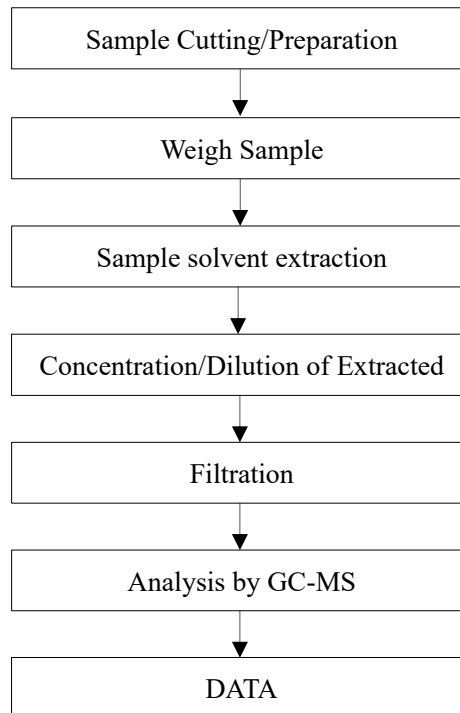

Any report having not been signed by authorized approver, or having been altered without authorization, or having not been stamped by the “Dedicated Testing/Inspection Stamp” is deemed to be invalid. Copying or excerpting portion of, or altering the content of the report is not permitted without the written authorization of AGC. The test results presented in the report apply only to the tested sample. Any objections to report issued by AGC should be submitted to AGC within 15days after the issuance of the test report. Further enquiry of validity or verification of the test report should be addressed to AGC by agc01@agccert.com.

Conditions of Issuance of Test Reports

1. All samples and goods are accepted by the Attestation of Global Compliance (Shenzhen) Std & Tech Co., Ltd. (the “Company”) solely for testing and reporting in accordance with the following terms and conditions. The company provides its services on the basis that such terms and conditions constitute express agreement between the company and any person, firm or company requesting its services (the “Clients”).
2. Any report issued by Company as a result of this application for testing services (the “Report”) shall be issued in confidence to the Clients and the Report will be strictly treated as such by the Company. It may not be reproduced either in its entirety or in part and it may not be used for advertising or other unauthorized purposes without the written consent of the Company. The Clients to whom the Report is issued may, however, show or send it, or a certified copy thereof prepared by the Company to its customer, supplier or other persons directly concerned. The Company will not, without the consent of the Clients, enter into any discussion or correspondence with any third party concerning the contents of the Report, unless required by the relevant governmental authorities, laws or court orders.
3. The Company shall not be called or be liable to be called to give evidence or testimony on the Report in a court of law without its prior written consent, unless required by the relevant governmental authorities, laws or court orders.
4. In the event of the improper use of the report as determined by the Company, the Company reserves the right to withdraw it, and to adopt any other additional remedies which may be appropriate.
5. Samples submitted for testing are accepted on the understanding that the Report issued cannot form the basis of, or be the instrument for, any legal action against the Company.
6. The Company will not be liable for or accept responsibility for any loss or damage however arising from the use of information contained in any of its Reports or in any communication whatsoever about its said tests or investigations.
7. Clients wishing to use the Report in court proceedings or arbitration shall inform the Company to that effect prior to submitting the sample for testing.
8. The Company is not responsible for recalling the electronic version of the original report when any revision is made to them. The Client assumes the responsibility to providing the revised version to any interested party who uses them.
9. Subject to the variable length of retention time for test data and report stored hereinto as otherwise specifically required by individual accreditation authorities, the Company will only keep the supporting test data and information of the test report for a period of six years. The data and information will be disposed of after the aforementioned retention period has elapsed. Under no circumstances shall we provide any data and information which has been disposed of after retention period. Under no circumstances shall we be liable for damage of any kind, including (but not limited to) compensatory damages, lost profits, lost data, or any form of special, incidental, indirect, consequential or punitive damages of any kind, whether based on breach of contract of warranty, tort (including negligence), product liability or otherwise, even if we are informed in advance of the possibility of such damages.

*** End of Report ***

Any report having not been signed by authorized approver, or having been altered without authorization, or having not been stamped by the “Dedicated Testing/Inspection Stamp” is deemed to be invalid. Copying or excerpting portion of, or altering the content of the report is not permitted without the written authorization of AGC. The test results presented in the report apply only to the tested sample. Any objections to report issued by AGC should be submitted to AGC within 15days after the issuance of the test report. Further enquiry of validity or verification of the test report should be addressed to AGC by agc01@agccert.com.